



ENCORE 52" X-TREME

2-BAG GRASS CATCHER

for units w/ S/N 53138 and above

ASSEMBLY AND PARTS DIAGRAMS

Notes:

ASSEMBLY INSTRUCTION

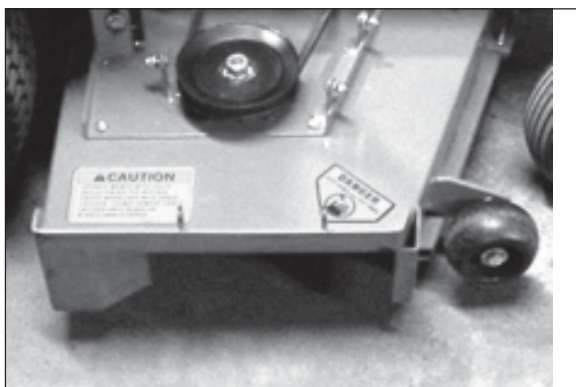

Figure 1
Using 1/2" wrench, remove the discharge cover and the RH deck belt shield from the deck.

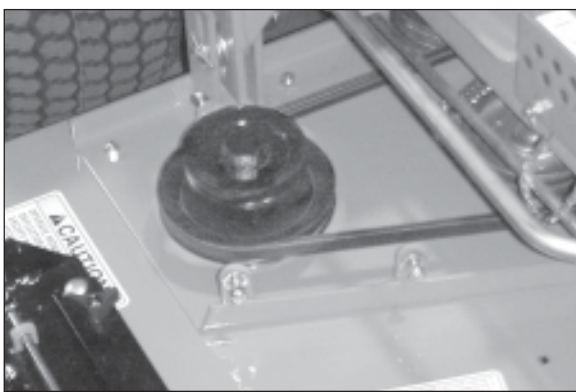

Figure 2
Remove retaining nut on RH spindle using a 1-1/8" socket and replace with threaded drive pulley supplied in the blower assembly box. Add loctite to the threads and tighten down drive pulley using 1-1/4" socket. Torque to 90 ft-lbs.

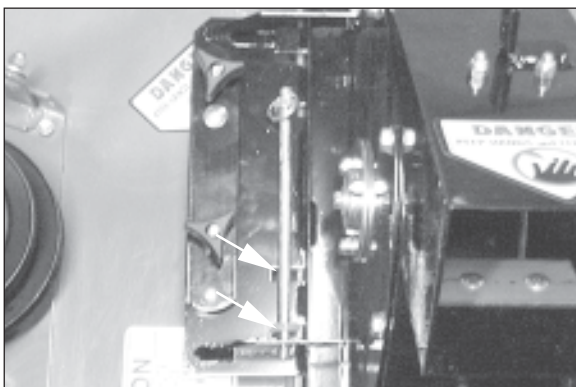

Figure 3
Install blower assembly using the front slots. Slide the blower retaining pin through mount tabs and tighten blower against retaining pin by tightening the elevator knobs mounted on the blower.

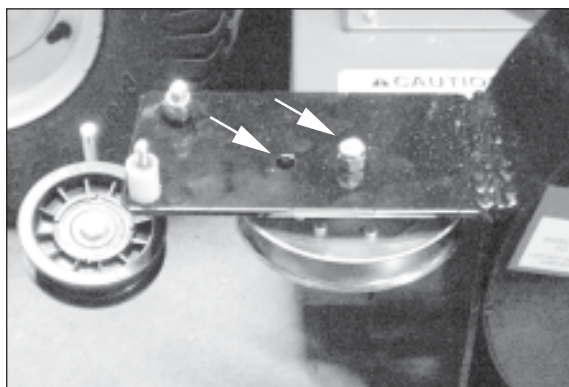

Figure 4
Using a 7/16" socket, remove the blower belt shield to locate the stationary V-idler. Make certain the V-idler is mounted in the front hole.

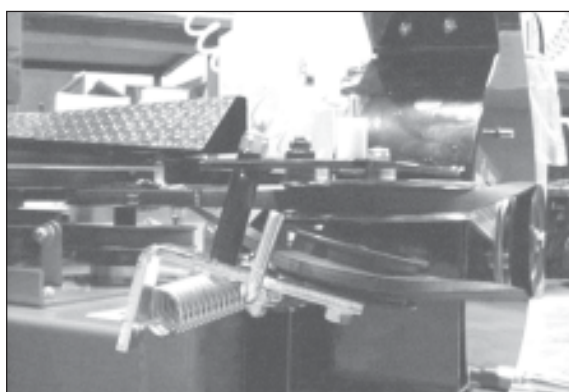

Figure 5
Install the blower drive belt by feeding the belt between the tensioner idler mount and the stationary V-idler. With the "V" portion of the belt riding inside the stationary V-idler, route the belt around towards the blower pulley. Wrap the belt clockwise over the top of the blower pulley giving it a half twist as it comes off the bottom and back towards the tensioner pulley making certain the backside of the belt rides against the tensioner idler. Finish by looping the belt over the drive pulley on the deck in a clockwise direction.

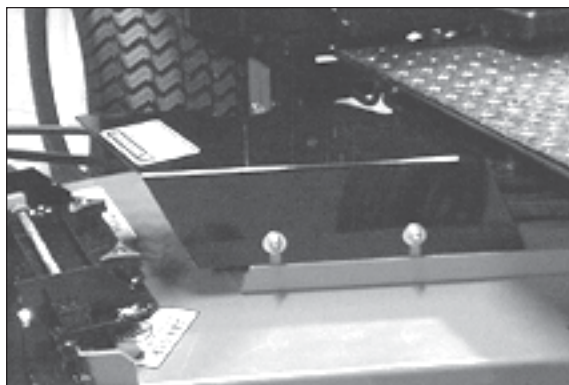

Figure 6
Install the spindle pulley guard found in the blower assembly box using the existing 5/16" washers and nyloc nuts.

ASSEMBLY INSTRUCTION



Figure 7
Remove the left front deck lift chain assembly and L-bracket by loosening the 3/8" whizlock nut and bolt from the deck mount tab and loosening the 3/8" nyloc nut and bolt that secures the chain assembly to the deck lift crank.

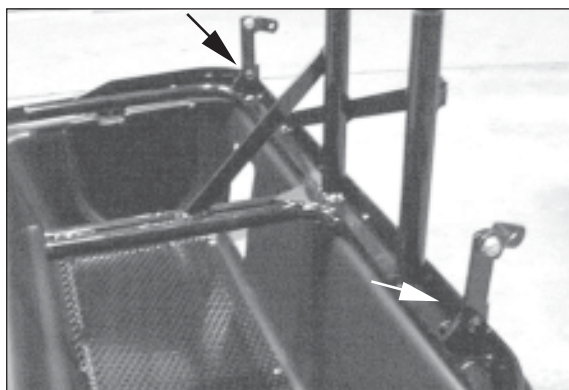

Figure 10
Lay the catcher hood on the floor upside down and slide pins on the catcher frame through the holes on the catcher hood. Secure into place using the 5/16" push nuts supplied in the bolt bag.

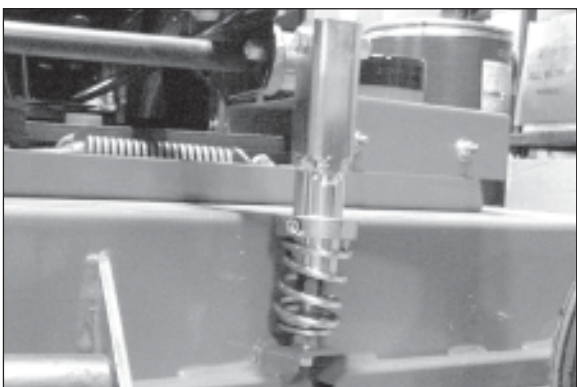

Figure 8
Install the counter balance assembly supplied in the hood box. Push down on the deck and slide clamp collar down onto the spring until there is resistance. Tighten down clamp collar.

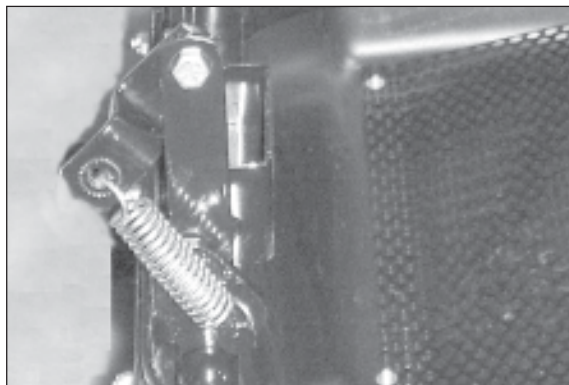

Figure 11
Mount tension springs supplied in the bolt bag onto the hood spring "Z" bracket and catcher frame pin.

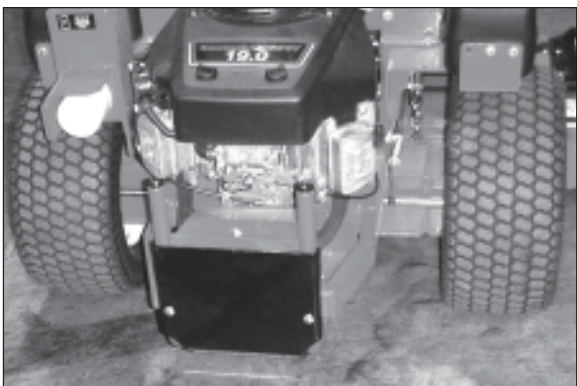

Figure 9
Remove the 5/16" bolts that secure the skid bars to the rear frame. Mount the grass catcher brace supplied in the hood box to the rear skid bars using the 5/16" x 2-1/2" carriage bolts supplied in the bolt bag. Use the existing 5/16" nyloc nuts.



Figure 12
Slide the assembled hood and frame onto the rear skid bars. Let the assembly slide all the way down to the grass catcher brace.

ASSEMBLY INSTRUCTION



Figure 13
Install the grass bags by sliding the mounting hook into the hanger mount.



Figure 14
Close the grass catcher hood & secure the hood latch.



Figure 15
Slide the upper grass tube into the opening of the catcher hood.



Figure 16
Fasten the tie-down strap to the blower hose adapter.



Figure 17
Install the grass tube and secure into place using two hose clamps found in the hood assembly box.



Figure 18

Attach the lower discharge tube to the blower assembly by hooking the tie down strap to the eyelet on the blower.



Figure 19
This completes the installation of your new Encore grass catcher system. *Note: When engaging the PTO switch; always make certain the unit is running 3/4 to full throttle so as to prevent stalling.*

X52 GRASS CATCHER BLOWER ASSY - 154036

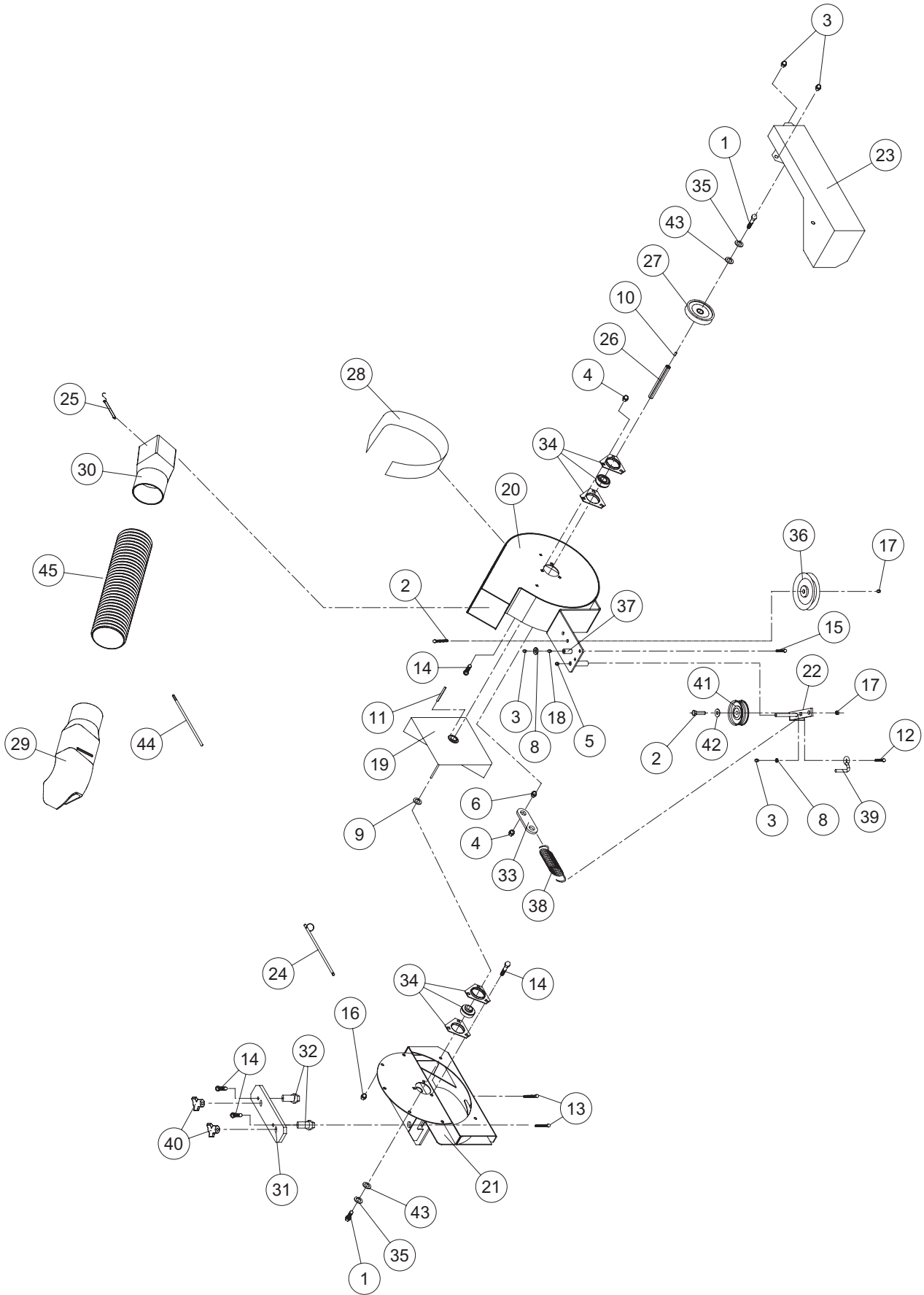

X52 GRASS CATCHER BLOWER ASSY - 154036

#	PART NO.	QTY	DESCRIPTION
1	100273	2	5/16-18 X 1 HHCS
2	100294	2	3/8"-16 X 1 1/2" HEX BOLT
3	104255	8	1/4"-20 NYLOC NUT
4	104256	7	5/16-18 NYLOC NUT
5	104257	1	3/8"-16 NYLOC NUT
6	104751	1	5/16-18 JAM NUT
7	-----	--	-----
8	105256	3	1/4" FLAT WASHER
9	105269	1	3/4 SAE FLATWASHER
10	107253	1	3/16" X 3/16" X 1/2" KEY
11	107266	1	3/16 X 3/16 X 2 MACH. KEY
12	107510	1	1/4"-20 X 1" CARRIAGE BOLT
13	107520	2	5/16"-18 X 1 3/4" TAP BOLT
14	107522	8	5/16"-18 X 5/8" CARRIAGE BOLT
15	107523	1	1/4"-20 X 1 1/2" CARRIAGE BOLT
16	109001	4	5/16"-18 WHIZLOCK NUT
17	109007	2	3/8"-16 WHIZLOCK NUT
18	109011	3	1/4 RETAINING CLIP
19	152016	1	IMPELLER
20	152020	1	HOUSING WELDMENT
21	152066	1	Z60 MOUNT WELDMENT
22	152024	1	IDLER ARM
23	152027	1	BELT COVER
24	153046	1	RING PIN
25	153050	1	BLOWER TIE DOWN
26	153066	1	DRIVE SHAFT
27	153072	1	PULLEY(DRIVEN)
28	153110	1	BLOWER LINER
29	153211	1	HOOD INLET ADPT.
30	153212	1	BLOWER HOSE ADPT.
31	153133	1	ADAPTER STRAP
32	153135	2	ADAPTER RAM
33	153138	1	SPRING MOUNT
34	153216	2	TRIANGLE FLANGE BEARING
35	363226	2	5/16 DISC SPRING WASHER
36	483025	1	IDLER PULLEY
37	523144	1	PIVOT BUSHING
38	523327	1	SPRING
39	553025	1	BELT GUIDE
40	753028	2	KNOB
41	823351	1	DRIVE IDLER
42	105259	1	3/8 SAE FLATWASHER
43	153240	2	IMPELLER SHAFT WASHER
44	153048	2	GRASS TUBE CLAMP
45	153217	1	GRASS TUBE 6"

X52 GRASS CATCHER HOOD ASSY - 154026

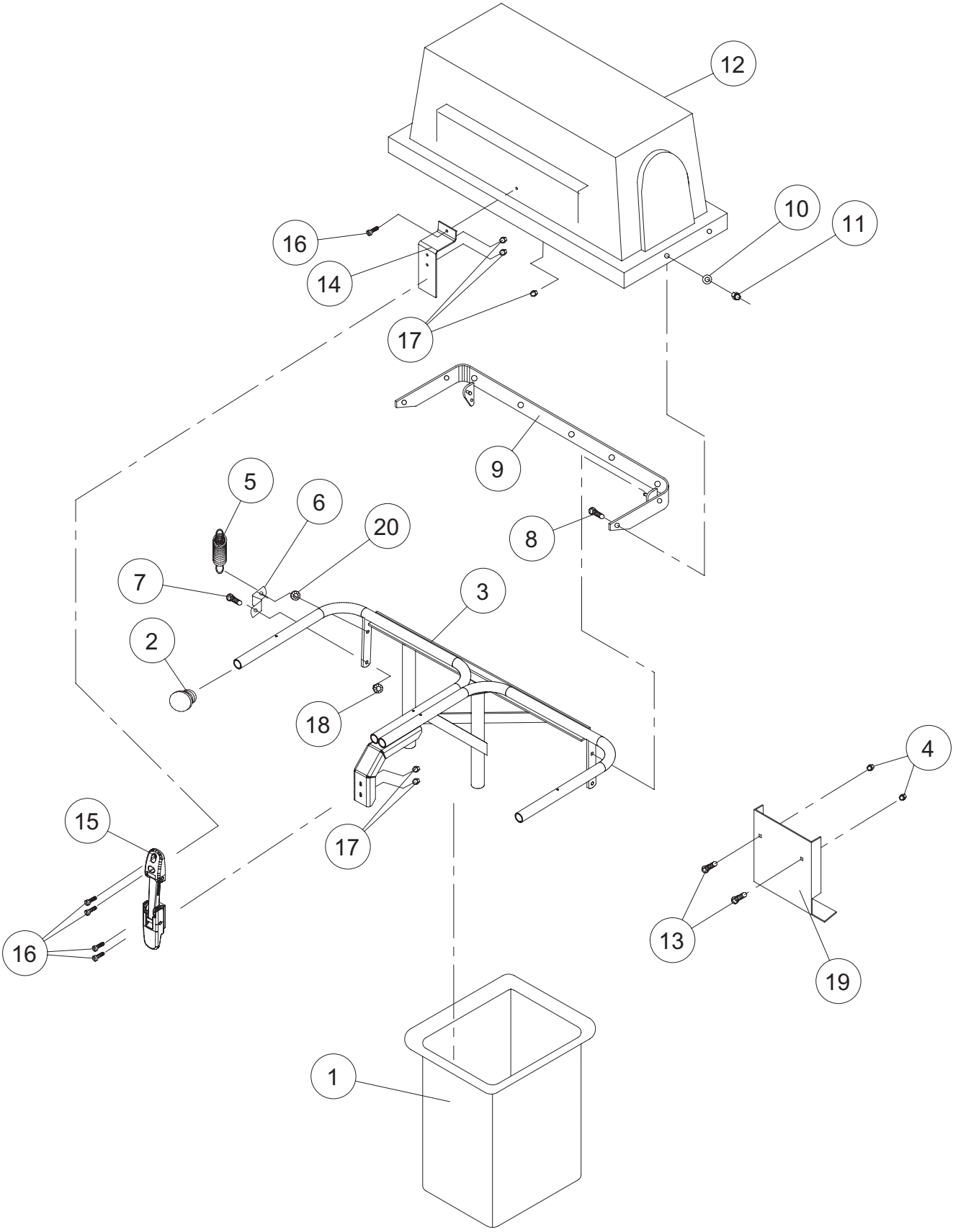

X52 GRASS CATCHER HOOD ASSY - 154026

#	PART NO.	QTY	DESCRIPTION
1	153171	2	SEWN BAG w/FRAME
2	523033	4	HANDLE PLUG
3	152052	1	BAG FRAME w/ LATCH
4	104256	2	5/16"-18 NYLOC NUT
5	523048	2	SPRING
6	153056	2	HOOD SPRING BRACKET
7	100271	2	5/16"-18 X 3/4" HEX BOLT
8	107502	10	1/4"-20 X 3/4" CARRIAGE BOLT
9	152009	1	HOOD STRAP
10	105256	10	1/4" FLAT WASHER
11	104255	10	1/4"-20 NYLOC NUT
12	153059	1	BLOWER HOOD
13	107512	1	5/16" X 2 1/2" CARRIAGE BOLT
14	153188	1	UPPER LATCH MOUNT
15	153218	1	HOOD LATCH
16	101039	5	#10-24 X 5/8" LG PAN HD SCREW
17	104252	5	#10-24 HEX NYLOCK NUT
18	109001	2	5/16"-18 WHIZLOCK NUT
19	153156	1	GRASS COLLECTOR BRACE
20	153045	2	5/16" PUSH NUT

OPTIONS:

532046	1	WEIGHT BRACKET KIT
821017	1	FC WEIGHT KIT (60 lb. weight)

X52 GRASS CATCHER COUNTER BALANCE ASSY

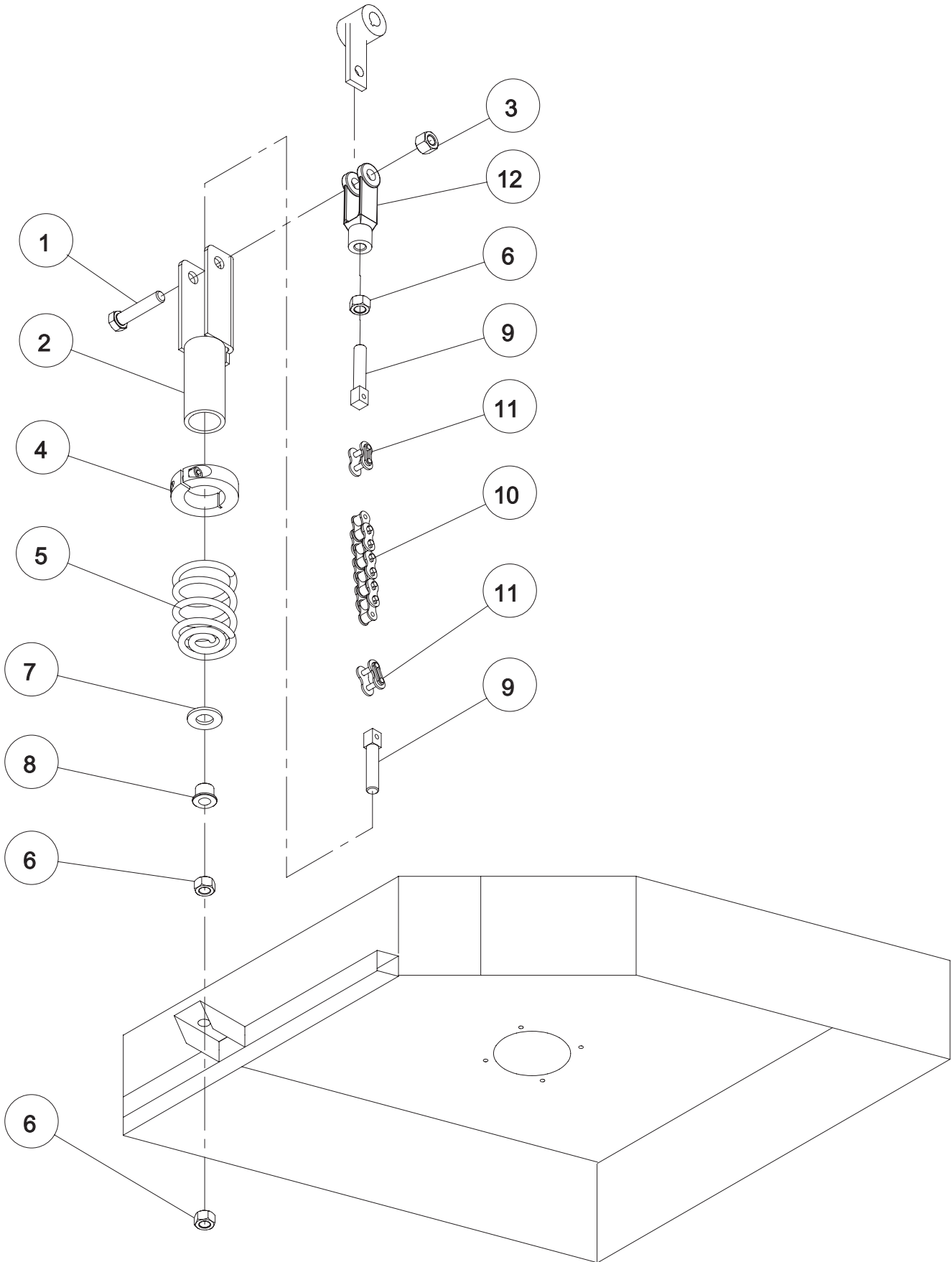

X52 GRASS CATCHER COUNTER BALANCE ASSY

#	PART NO.	QTY	DESCRIPTION
1	100295	1	3/8"-16 X 1 3/4" LG HHCS
2	152029	1	COUNTER BALANCE WLDMT
3	104257	1	3/8" NYLOC NUT
4	153162	1	SPRING CLAMP
5	523278	1	SPRING
6	109008	3	3/8" UNF WHIZLOCK
7	105264	1	1/2" STD FLATWASHER
8	123044	1	PIN BUSHING
9	523125	2	ANCHOR STUD
10	423180	1	FRONT LIFT CHAIN
11	523123	2	CONNECTOR LINK
12	363192	1	LARGE YOKE

NOTE: ONLY SOLD AS INDIVIDUAL PARTS

