



72B850P

**PARTS
MANUAL**



**72" MID-CUT
GAS ENGINE
OPTION
SECTION**

72" MID-CUT DECK ASSEMBLY

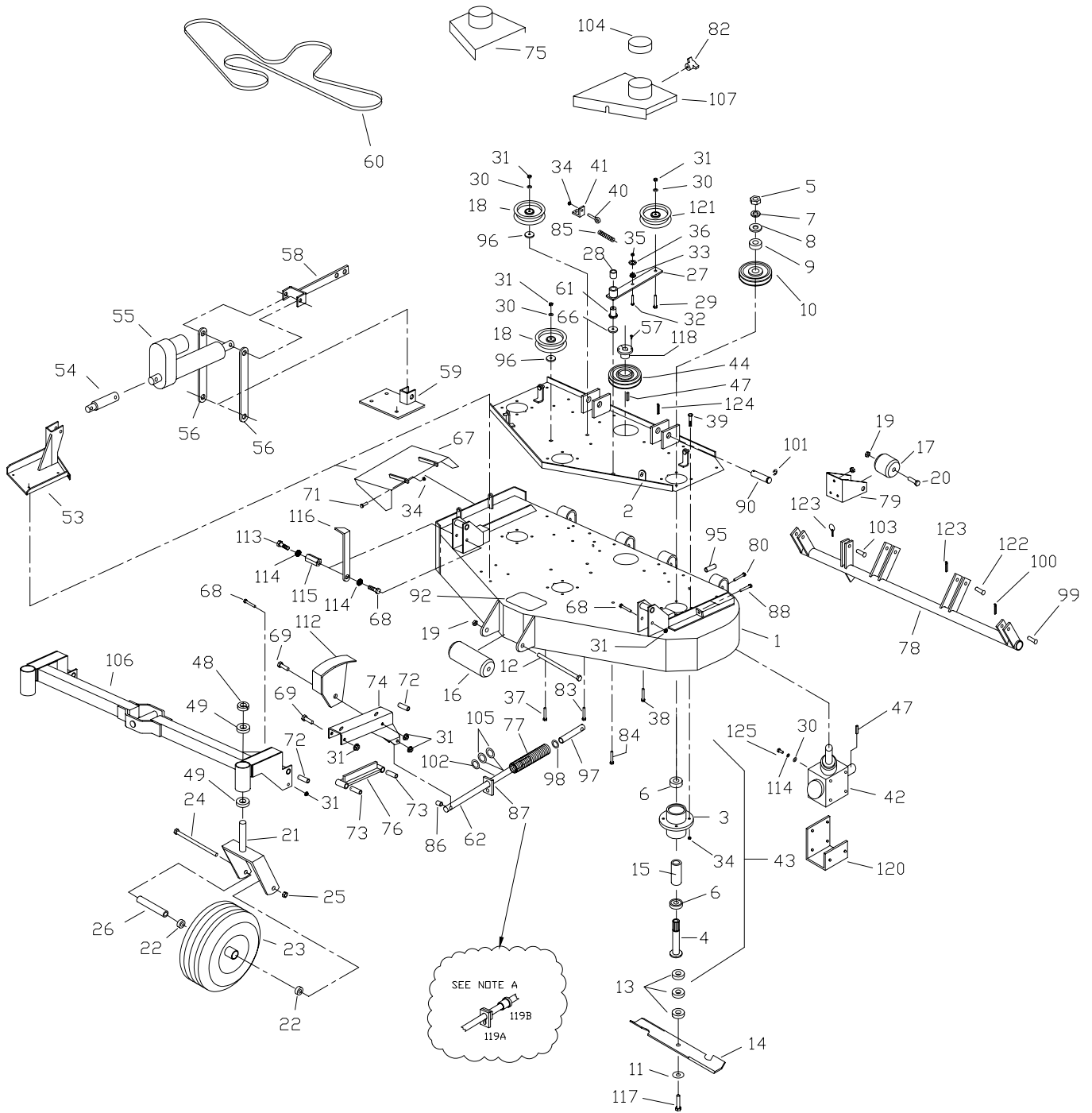

72" Mid-Cut Deck Assembly

#	PART NO.	QTY	DESCRIPTION
1	582096	1	72" MC DECK WELDMENT
2	582098	1	72" DECK CHANNEL
3	583111	3	SPINDLE HOUSING
4	583112	3	SPINDLE SHAFT
5	104511	3	3/4"-16 HEX NUT
6	363350	6	BEARING - BLADE SPINDLE
7	105010	3	3/4" LOCK WASHER
8	105269	3	3/4" SAE FLAT WASHER
9	583110	3	PULLEY SPACER
10	583107	3	PULLEY - SPINDLE 5 3/4"
11	583108	3	5/8" SPRING DISC WASHER
12	100351	1	5/8"-11 X 8 1/2" HEX BOLT
13	583109	9	BLADE SPACER
14	583287	3	25" OFFSET BLADE
15	583113	3	BEARING SPACER TUBE
16	603023	1	ANTI-SCALP ROLLER
17	523084	2	REAR DECK ROLLER
18	583162	2	6" FLAT IDLER
19	104261	3	5/8"-11 NYLOC NUT
20	100346	2	5/8"-11 X 4 1/2" HEX BOLT
21	822088	2	WIDE TAIL WHEEL STRUT
22	363187	4	1" BEARING
23	823220	2	WIDE TAIL WHEEL (COMPLETE)
23A	823339	X	TIRE (13 X 6.5 X 6)
23B	823338	X	FRONT RIM W/ VALVESTEM
24	100352	2	5/8"-11 X 9" HEX BOLT
25	104261	2	5/8"-11 NYLOC NUT
26	823245	2	AXLE TUBE (WTW)
27	822144	1	DECK IDLER ARM W/BUSHING
28	363007	1	3/4" FLANGE BUSHING
29	107511	1	3/8"-16 X 2" CARRIAGE BOLT
30	105260	8	3/8" FLAT WASHER
31	104257	16	3/8"-16 NYLOC NUT
32	100275	1	5/16"-18 X 1 1/2" HEX BOLT
33	109001	2	5/16"-18 WHIZLOCK NUT
34	104256	36	5/16"-18 NYLOC NUT
35	109007	2	3/8"-16 WHIZLOCK NUT
36	105258	9	5/16" FLAT WASHER
37	107503	10	5/16"-18 X 3/4" CARRIAGE BOLT
38	107509	5	5/16"-18 X 1" CARRIAGE BOLT
39	100274	12	5/16"-18 X 1 1/4" HEX BOLT
40	363080	1	EYEBOLT - RIGHT
41	523094	1	SPRING MOUNT - DECK
42	583166	1	GEAR BOX LARGE
43	583106	3	BLADE SPINDLE ASSY
44	583447	1	6" TAPER LOCK SHEAVE
46	105005	4	5/16" LOCK WASHER
47	107255	1	3/16" X 1" KEY
48	363145	2	1" CLAMP COLLAR
49	363187	2	1" FLANGE BEARING

72" Mid-Cut Deck Assembly

#	PART NO.	QTY	DESCRIPTION
53	582182	1	MC LIFT RISER WELDMENT
54	583236	1	ACTUATOR EXTENSION
55	583294	1	ELECTRIC ACTUATOR
56	583499	2	E.L. PIVOT ARM
57	100252	6	1/4"-20 X 3/4" HEX BOLT
58	582217	1	E.L. RAM WELDMENT
59	582215	1	E.L. PIVOT MOUNT WELDMENT
60	583153	1	72" DECK BELT
61	423175	1	PUMP IDLER PIVOT
62	583474	2	CASTER ROD
66	373089	1	3/8" RETAINING WASHER
67	582108	1	DEFLECTOR SHIELD 72"
68	100300	4	3/8"-16 X 3" HEX BOLT
69	100301	4	3/8"-16 X 3 1/4" HEX BOLT
71	100273	2	5/16"-18 X 1" HEX BOLT
72	823330	4	CASTER ARM PIVOT
73	823090	4	CASTER BAR PIVOT
74A	582053	1	LEFT HAND CASTER ARM
74B	582051	1	RIGHT HAND CASTER ARM
75	582100	1	RIGHT HAND BELT SHIELD
76	582059	2	CASTER BAR WELDMENT
77	823150	2	SPRING
78	582112	1	72" DECK TUBE WELDMENT
79	583074	2	ROLLER MOUNT
80	100298	2	3/8"-16 X 2 1/2" HEX BOLT
82	753028	4	KNOB
83	107516	2	3/8" X 2 1/4" CARRIAGE BOLT
84	107513	3	3/8"-16 X 3" CARRIAGE BOLT
85	593074	1	FLOATING IDLER SPRING
86	823153	2	SPACER - DECK
87	823159	2	SPRING SLIDE
88	100030	2	3/8"-16 X 3" TAP BOLT
90	823333	2	DECK ATTACH PIN
91	108001	3	3/16" QUICK PIN
92	823200	1	STEP TREAD
95	823314	2	TUBE SADDLE SPACER
96	483017	2	RIGHT HAND IDLER SPACER
97	583472	2	CASTER ROD END
98	109025	2	5/8" HEAVY WASHER
99	823210	2	1/2" X 2" CLEVIS PIN
100	106763	2	1/8" COTTER PIN
101	108510	4	7/8" E-RING
102	373078	2	CASTER SHIM WASHER
103	823209	2	1/2" X 1 1/2" CLEVIS PIN
104	363161	3	BELT SHIELD CAP
105	583393	4	DECK ROD WASHER
106	582090	1	FRONT AXLE - 72MC
108	582102	1	BELT SHIELD LEFT HAND 72"
111	582176	1	CUT GAGE WELDMENT

72" Mid-Cut Deck Assembly

#	PART NO.	QTY	DESCRIPTION
113	100291	1	3/8"-16 X 3/4" HEX BOLT
114	105006	2	3/8" LOCKWASHER
115	583422	1	NUT-CUT GAGE
116	583420	1	POINTER CUT GAGE
117	100347	3	5/8"-11 X 2" HEX BOLT
118	363215	1	1" TAPER LOCK HUB
119A	592006	1	SPRING RETAINER
119B	363007	1	FLANGE BUSHING
120	593096	1	GEAR BOX TRUSS
121	523329	1	FLOATING IDLER - FLAT
122	823211	2	1/2" X 2 1/2" RING PIN
123	106778	3	3/16" X 1 1/2" COTTER PIN
124	108001	2	3/16" QUICK PIN
125	100293	4	3/8"-16 X 1 1/4" HHCS

NOTES:

- A PERFORMANCE UPGRADE FOR DECK SPRING ASSY. REQUIRES ITEM 119.
BOTH SIDES NEED BE UPGRADED AT THE SAME TIME.

72" Mid-Cut Mainframe Assembly

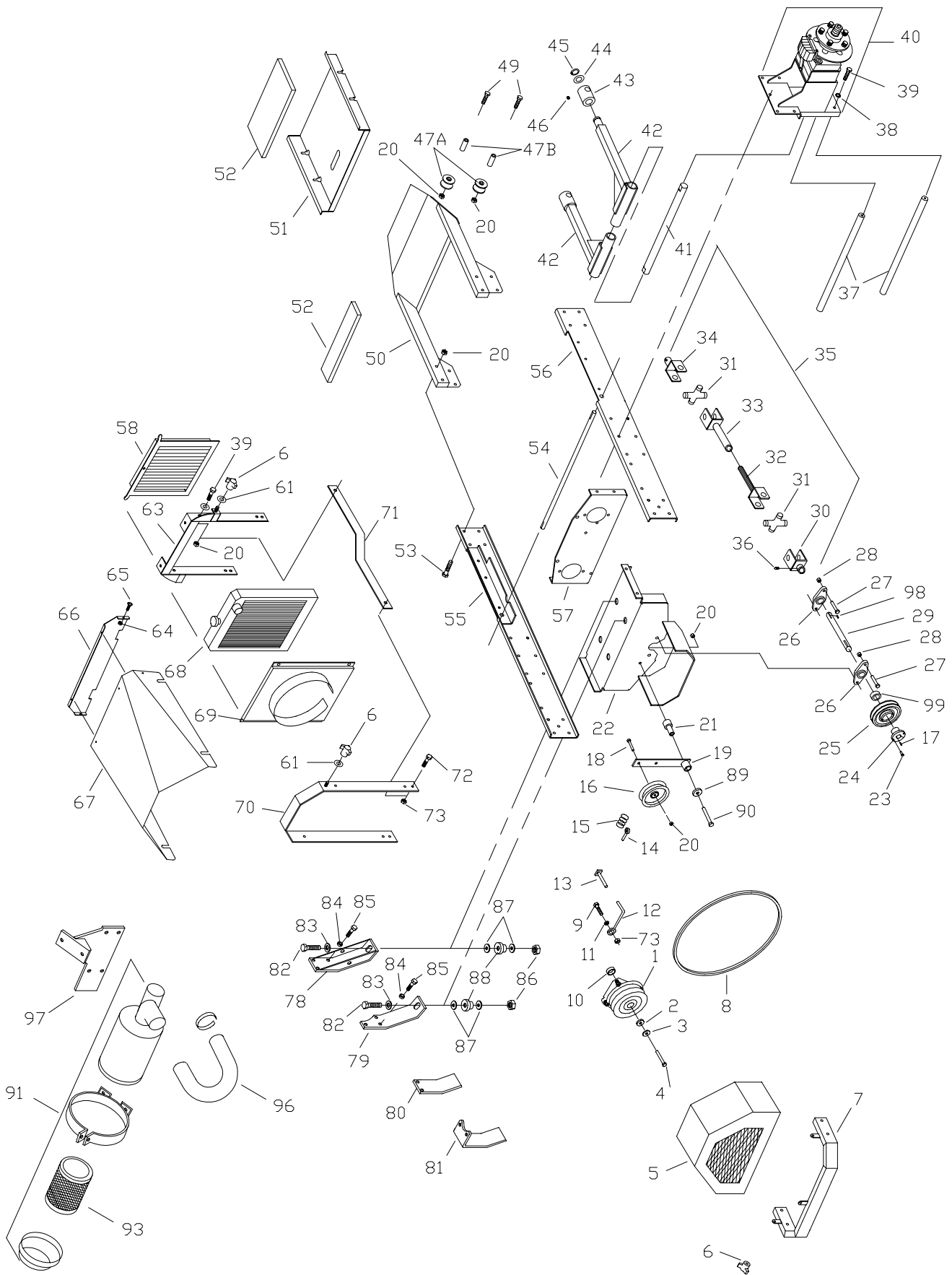

72" Mid-Cut Mainframe Assembly

27 HP KAW
31 HP BRIGGS

#	PART NO.	QTY	DESCRIPTION		
1A	583518	1	ELECTRIC CLUTCH - 200 FT/LBS	X	
1B	583308	1	ELECTRIC CLUTCH		X
2	373089	1	RETAINER WASHER		
3	423069	2	7/16" SPRING DISC WASHER		
4	100534	1	7/16"-20 X 1 1/4" HEX BOLT		
5	582157	1	CLUTCH COVER - IL3		X
5A	822146	1	REAR COVER WELDM'T	X	
5A	823335	2	REAR COVER - STRAP	X	
5A	583221	1	REAR COVER - KAW	X	
6	753028	7	KNOB		
7	582132	1	ENGINE GUARD		X
7A	582061	1	ENGINE GUARD	X	
8	523374	1	CLUTCH BELT		X
8A	583517	1	CLUTCH BELT	X	
9	100273	16	5/16"-18 X 1" HEX BOLT		
10	823248	2	CLUTCH SPACER 9/32		
11	105258	6	5/16" FLAT WASHER		
12	363075	1	ROUND BELT GUIDE		
13	582169	1	CLUTCH STOP		
14	363080	1	RIGHT EYE BOLT		
15	593074	1	IDLER SPRING HH		
16	483025	1	RIGHT HAND IDLER PULLEY		
17	107259	1	1/4" X 1/4" X 1" KEY		
18	100294	6	3/8"-16 X 1 1/2" HEX BOLT		
19	422025	1	TENSIONER W/BUSHING		
19A	523111	X	BUSHING (SERVICE)		
20	104257	32	3/8"-16 NYLOC NUT		
21	823030	1	PUMP IDLER SUPPORT		
22A	582163	1	ENGINE BASE 31 GAS MC		X
22B	582043	1	ENGINE BASE	X	
23	100503	2	1/4" X 3/4" HEX BOLT		
24	363215	1	TAPER LOCK HUB		
25	363216	1	TAPER LOCK SHEAVE		
26	823032	2	2-BOLT FLANGE BEARING		
27	100311	4	7/16"-14 X 1 1/4" HEX BOLT		
28	104258	4	7/16"-14 NYLOC NUT		
29	583271	1	POWER SHAFT - MC - DSL		X
29A	583080	1	POWER SHAFT - MC	X	
30	523414	1	1" YOKE		
31	523415	2	CROSS & BEARING		
32	593075	1	YOKE SHAFT		
33	583481	1	YOKE TUBE		
34	823372	1	3/4" YOKE		
35	593064	1	DRIVE SHAFT MC		
36	103295	2	3/8"-16 X 1/2" SET SCREW		
37	823066	2	BRACE ROD - LOWER		
38	105006	6	3/8" LOCK WASHER		
39	100292	23	3/8"-16 X 1" HEX BOLT		
40			SEE HYDRAULIC ILLUSTRATION		
41	823050	1	DECK ARM SHAFT		

72" Mid-Cut Mainframe Assembly

27 HP KAW
31 HP BRIGGS

#	PART NO.	QTY	DESCRIPTION		
42	822036	2	DECK ARM		
43	822090	2	DECK SWIVEL W/ZERK		
44	823015	4	DECK ARM WASHER		
45	108502	2	SNAP RING		
46	111004	12	1/4"-28 GREASE ZERK		
47	583464	2	FRONT ROLLER - MC (REF ONLY)		
47A	583464	2	FRONT ROLLER		
47B	583490	2	FRONT ROLLER TUBE		
49	100298	2	3/8"-16 X 2 1/2" HEX BOLT		
50	582092	1	FRONT FRAME		
51	582094	1	FOOT PLATE		
52	583374	1	FOOT REST PAD LARGE		
52	583373	1	FOOT REST PAD SMALL		
53	100295	4	3/8"-16 X 1 3/4" HEX BOLT		
54	823140	1	PARK SHAFT		
55	582124	1	LEFT HAND FRAME RAIL		X
55A	582041	1	LEFT HAND FRAME RAIL	X	
56	582126	1	RIGHT HAND FRAME RAIL		X
56A	582039	1	RIGHT HAND FRAME RAIL	X	
57			SEE HYDRAULIC ILLUSTRATION		
58	583301	1	RADIATOR SCREEN		
61	105260	13	3/8" FLAT WASHER		
63	582159	1	RADIATOR MOUNT		
64	104252	15	#10-24 NYLOC NUT		
65	101039	17	#10-24 X 5/8" SCREW		
66	583010	1	FRONT ENGINE COVER - IL3		
67	583296	1	ENGINE COVER		
68	SEE NOTE A	1	RADIATOR ASSY.		
69	583476	1	FAN SHROUD		
70	582161	1	HOOD BRACE		
71	583356	2	HOOD SIDE BRACE		
72	100271	4	5/16"-18 X 3/4" HEX BOLT		
73	104256	5	4/16"-18 NYLOC NUT		
78	583250	2	ENGINE MOUNT FRONT		
79	582116	2	ENGINE MOUNT - 3 CYL.		
80	582151	1	FUEL PUMP MOUNT		
81	582134	1	FUEL FILTER MOUNT		
82	100331	4	1/2"-13 X 2 1/2" HEX BOLT		
83	105264	4	1/2" FLAT WASHER		
84	105005	6	5/16" LOCK WASHER		
85	109031	6	M8-1.25 X 20MM HEX BOLT		
86	104259	4	1/2"-13 NYLOC NUT		
87	105264	8	1/2" STANDARD FLAT WASHER		
89	373089	1	RETAINING WASHER		
90	100300	2	3/8"-16 X 3" HEX BOLT		
91	583297	1	AIR CLEANER ASSY STRAIGHT		
93	583298	1	AIR FILTER ELEMENT		
96	583369	1	AIR FILTER HOSE U-SHAPE		
97	582153	1	AIR FILTER MOUNT		

72" Mid-Cut Mainframe Assembly

27 HP KAW
31 HP BRIGGS

#	PART NO.	QTY	DESCRIPTION		
98	107258	1	POWER SHAFT KEY		
99	363145	1	1" CLAMP COLLAR		

NOTE:

A CONTACT ENGINE MFG FOR ALL ENGINE & RADIATOR PARTS NOT SHOWN. **ENCORE MFG DO NOT SERVICE THESE PARTS!**

72" Mid-Cut Seatframe Assembly

27 HP KAW
31 HP BRIGGS

#	PART NO.	QTY	DESCRIPTION		
1	583154	2	FUEL TANK - MC		
2	393042	2	GROMMET		
3	583183	2	FUEL TANK ADAPTER		
4	523283	1	HOUR METER		
5	523278	2	SEAT SPRING		
6	583438	2	ADJUSTMENT PLATE		
7	104752	4	5/16"-24 JAM NUT		
8	823221	4	10MM BALL STUD		
9	583415	2	DAMPENER CONTROL		
10	583046	2	BACK PLATE TAB		
11	153045	2	5/16" PUSH NUT		
12A	583065	1	RIGHT FENDER		
12B	583064	1	LEFT FENDER		
14	363165	1	HAIR PIN COTTER		
15	523044	1	SEAT CABLE		
16	523105	1	SEAT HINGE		
17A	582110	1	LEFT HAND PIVOT W/BUSHING		
17B	582109	1	RIGHT HAND PIVOT W/BUSHING		
18	253059	2	ENGAGEMENT BUSHING		
19	822054	1	SEAT FRAME WELDMENT		
20	583028	1	FRONT - SEAT FRAME		
21	822058	1	SEAT PLATE		
22	373089	2	RETAINING WASHER		
23	523222	2	CONTROL LEVER ANG.E		
24	582048	1	PARK LEVER W/GRIP		
25	363105	1	IDLER BUSHING		
26	583140	1	PUMP CONTROL LINK - LH		
27	453082	2	5/16"-24 ROD END - MALE		
28	423160	2	5/16"-24 BALL STUD		
29	583138	1	PUMP CONTROL LINK - RH		
30	823132	1	PARK BRAKE LINK		
31	363029	2	5/16" ROD SWIVEL		
32A	582084	1	LH NEUTRAL LOCK PIVOT		
32B	582082	1	RH NEUTRAL LOCK PIVOT		
33	822075	2	DRIVE BLOCK W/ZERK		
34	111004	2	1/4"-24 ZERK		
35	363024	4	COMPRESSION SPRING		
36	104259	4	1/2"-13 NYLOC NUT		
37	105264	2	1/2" FLAT WASHER		
38	100275	2	5/16"-18 X 1 1/2" HEX BOLT		
39	109001	8	5/16"-18 WHIZLOCK NUT		
40	105260	6	3/8" FLAT WASHER		
41	109015	8	1/4"-20 NUT CLIP		
42	363257	2	FUEL CAP W/GASKET		
43	583050	1	FUEL VALVE		
44	101039	5	#10-28 X 5/8" SCREW		
45	104252	4	#10-28 NYLOC NUT		
46	103004	2	1/4"-14 X 3/4" SCREW		
47	102000	7	#12-24 CUTTING SCREW		
48	100252	8	1/4"-20 X 3/4" HEX BOLT		

72" Mid-Cut Seatframe Assembly

27 HP KAW
31 HP BRIGGS

#	PART NO.	QTY	DESCRIPTION	27 HP KAW	31 HP BRIGGS
49	100004	8	1/4"-20 X 1" HEX BOLT		
50	109000	8	1/4"-20 WHIZLOCK NUT		
51	100271	8	5/16"-18 X 3/4" HEX BOLT		
52	100273	2	5/16"-18 X 1" HEX BOLT		
53	583091	2	ARM REST PAD KIT		
53A	583242	1	ARM REST - LEFT HAND		
53B	583243	1	ARM REST - RIGHT HAND		
54	104256	20	5/16"-24 NYLOC NUT		
55	523030	1	SEAT SWITCH		
56	363113	4	WHEEL PULLEY SPACER		
57	105258	11	5/16" FLAT WASHER		
58	583089	1	SEAT CUSHION		
59	583090	1	BACK CUSHION		
60	100274	2	5/16"-18 X 1 1/4" HEX BOLT		
61	583077	1	SEAT		
62	523033	2	HANDLE PLUG		
63	100303	1	3/8"-16 X 4" HEX BOLT		
64	100305	2	3/8"-16 X 4 1/2" HEX BOLT		
65	104257	3	3/8"-16 NYLOC NUT		
66	523032	2	HANDLE GRIP		
67	363201	4	TANK PAD		
68A	523017	2	HANDLE W/O GRIP & PLUG		
68B	522100	2	HANDLE COMPLETE W/GRIP & PLUG		
69	363098	5	FUEL LINE CLAMP		
70A	583054	1	TANK BACK PLATE - LH		
70B	583052	1	TANK BACK PLATE - RH		
71A	582065	1	FUEL TANK SADDLE LEFT HAND		
71B	582045	1	FUEL TANK SADDLE RIGHT HAND		
72A	583186	1	FUEL LINE LEFT HAND		
72B	583185	1	FUEL LINE RIGHT HAND		
73	583037	1	CONTROL PANEL		
74A	583254	1	RIGHT HAND LEVER LOCK		
74B	583256	1	LEFT HAND LEVER LOCK		
75	104255	2	1/4"-20 NYLOC NUT		
76	107520	2	5/16"-18 X 3/4" HEX BOLT		
77	583188	1	BATTERY MOUNT - KAWASAKI ONLY	X	
78	583401	1	BATTERY MOUNT		X
79	583519	1	FULL SUSPENSION SEAT		

72" Mid-Cut Large Hydro Pump Assembly

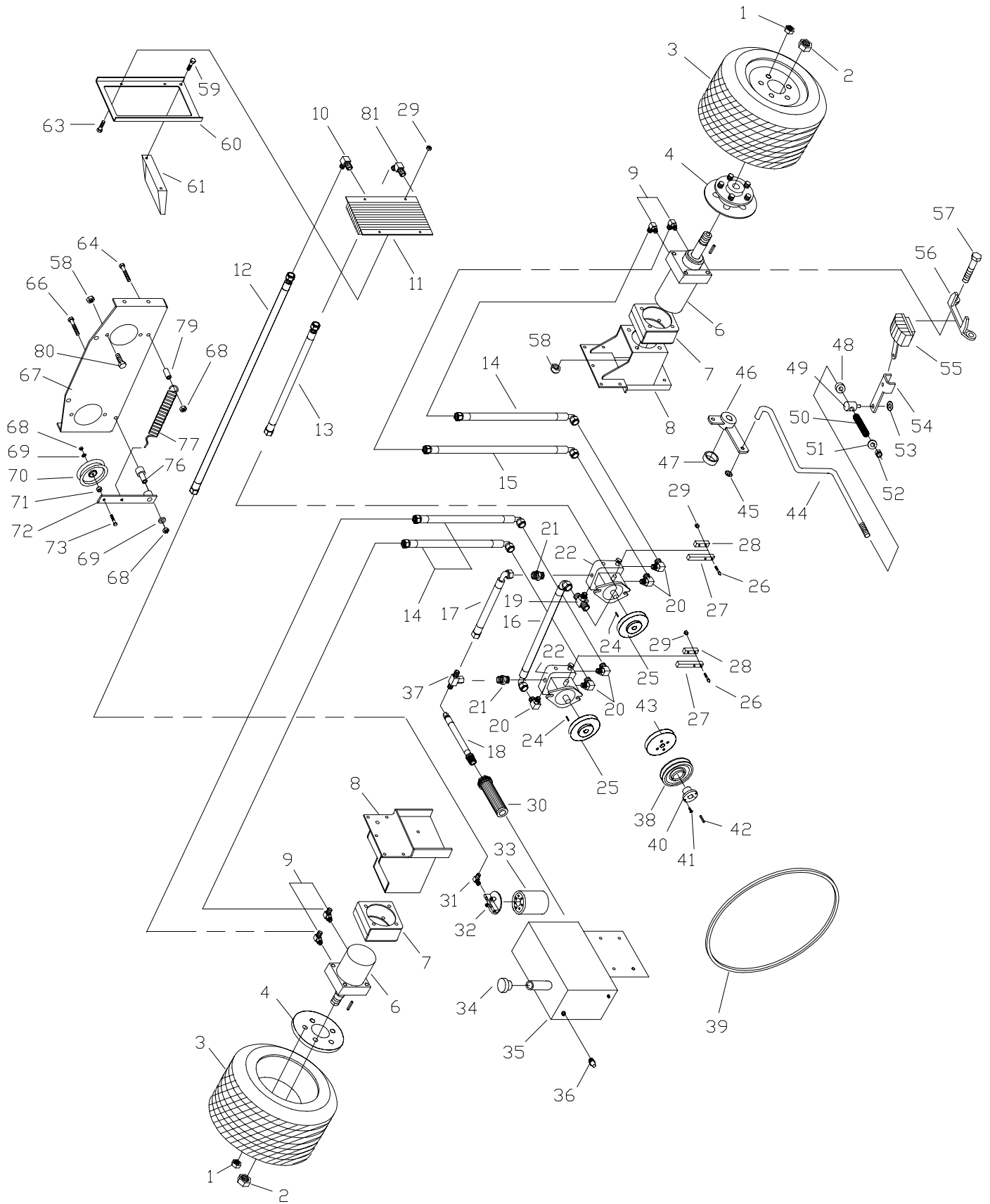

72" Mid-Cut

Hydraulic Assembly (21L Series)

#	PART NO.	QTY	DESCRIPTION
1	103023	10	1/2" LUG NUT
2	104511	2	3/4"-16 HEX NUT
3	583055	2	DRIVE WHEEL ASSY (COMPLETE)
3A	583059	X	DRIVE TIRE (24 X 12 X 12)
3B	583487	X	BAR LUG TIRE (23 X 10.5 X 12)
3C	583058	X	RIM W/ VALVESTEM
4	582008	2	WHEEL HUB
6	583022	2	LARGE WHEEL MOTOR - MP24
6A	583520	X	SEAL KIT - MP24
7	582031	4	MOTOR SPACER
8A	582002	1	RIGHT HAND MOTOR MOUNT
8B	582004	1	LEFT HAND MOTOR MOUNT
9	523058	4	RETURN ADPT.
10	583214	2	OIL COOLER ADAPTER
11	583201	1	OIL COOLER
12	583216	1	COOLER TO FILTER HOSE
13	583215	1	PUMP TO COOLER HOSE
14	583461	3	21" HOSE
15	583462	1	26 3/4" HOSE
16	583124	1	PUMP TO PUMP RETURN HOSE
17	583131	1	PUMP TO PUMP SUPPLY HOSE
18	583130	1	TANK TO PUMP SUCTION HOSE
19	583127	1	SUPPLY TEE
20	453113	5	PUMP ELBOW
21	583126	2	STRAIGHT ADAPTER
22	583081	2	LARGE V-PUMP (BDP-21LH)
22A	583377		PUMP SEAL KIT - (BDP-21LH)
24	453102	2	PUMP KEY (5MM)
25	583092	2	PUMP PULLEY
26	100257	4	1/4"-20 X 1 3/4" HEX BOLT
27	823104	2	PUMP CONTROL BAR
28	453090	2	CLAMP BAR
29	104255	6	1/4"-20 NYLOC NUT
30	583132	1	SUCTION SCREEN
31	583129	1	FILTER ADAPTER
32	423064	1	FILTER HEAD
33	423063	1	HYDRO OIL FILTER (NO CROSS REF AVAIL)
34	423165	1	OIL BREATHER CAP
35	583049	1	OIL TANK
36	423065	1	OIL EYE
37	523128	1	TENSIONER SWIVEL
38	583217	1	PUMP DRIVE PULLEY (ENGINE)
39	823026	1	PUMP BELT
40	363215	1	TAPER LOCK HUB
41	100252	2	1/4"-20 X 3/4" HEX BOLT
42	107258	2	1/4" X 1/4" X 3/4" KEY
43	583274	1	FRONT DRIVE ADAPTER
44A	583042	1	RIGHT HAND BRAKE ROD
44B	583044	1	LEFT HAND BRAKE ROD
45	153045	3	5/16" PUSH NUT

72" Mid-Cut

Hydraulic Assembly (21L Series)

#	PART NO.	QTY	DESCRIPTION
46	422049	1	BRAKE CRANK
47	373086	1	BLADE SPACER
48	523112	2	5/16" CLAMP COLLAR
49	423130	2	PARK BRAKE SWIVEL
50	523024	2	DECK DR. SPRING
51	105258	2	5/16" FLAT WASHER
52	104256	20	5/16" NYLOC NUT
53	363177	2	3/8" PUSH NUT
54	583460	2	BRAKE ARM
55A	583038	1	RIGHT HAND BRAKE CALIPER
55B	583039	1	LEFT HAND BRAKE CALIPER
55C	583511	X	BRAKE PAD KIT
56	583040	2	CALIPER MOUNT BRACKET
57	100343	8	1/2"-13 X 9" HEX BOLT (72")
58	104261	12	1/2"-13 NYLOC NUT
59	100273	16	5/16"-18 X 1" HEX BOLT
60	583204	1	OIL COOLER CHANNEL
61	582167	1	OIL COOLER MOUNT - 3 CYL
63	100252	6	1/4"-20 3/4" HEX BOLT
64	100300	2	3/8"-16 X 3" HEX BOLT
66	100303	2	3/8"-16 X 4" HEX BOLT
67	582076	1	PUMP PLATE
68	104257	32	3/8" NYLOC NUT
69	105260	13	3/8" FLAT WASHER
70	823351	1	PUMP DRIVE IDLER
71	523277	1	IDLER SPACER
72	422025	1	TENSIONER W/BUSHING
72A	523111	X	BUSHING (SERVICE)
73	107501	2	3/8"-16 X 2" CARRIAGE BOLT
76	823030	2	PUMP IDLER SUPPORT
77	583144	1	PUMP IDLER SPRING
79	393070	1	DRIVE IDLER BUSHING
80	100327	4	1/2"-13 X 1 1/2" HEX BOLT
81	583444	1	OIL COOLER ADAPTER 45 DEGREE

72" Mid-Cut Small Hydro Pump Assembly

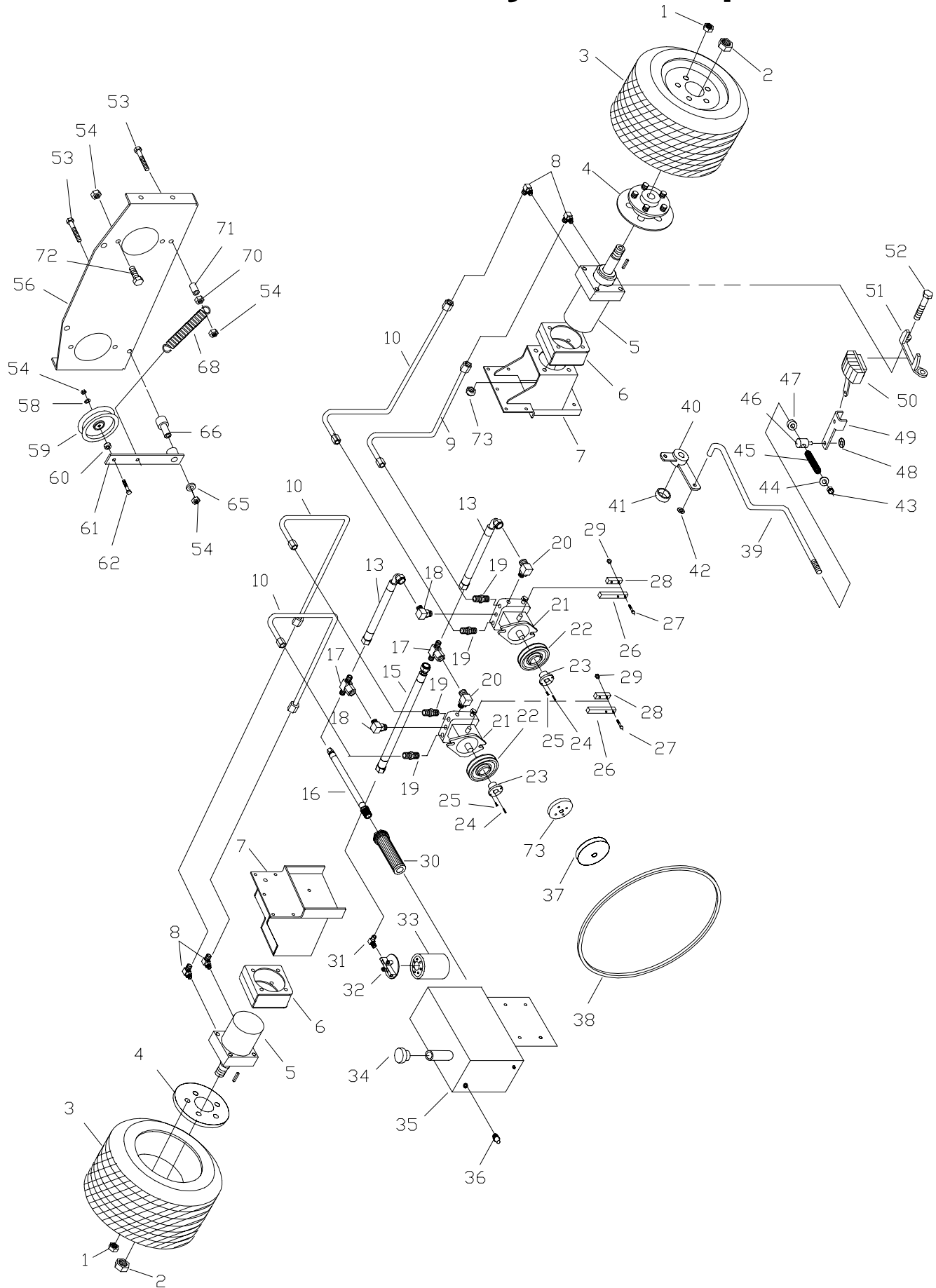

72" Mid-Cut

Small Hydro Pump Assembly

#	PART NO.	QTY	DESCRIPTION
1	103023	10	LUG NUT
2	104511	2	WHEEL NUT
3	583055	2	DRIVE WHEEL ASSY (COMPLETE)
3A	583059	X	DRIVE TIRE (24 X 12 X 12)
3B	583487	X	BAR LUG TIRE (23 X 10.5 X 12)
3C	583058	X	RIM W/ VALVESTEM
4	582008	2	WHEEL HUB
5	583325	2	WHEEL MOTOR
6	582031	4	MOTOR SPACER
7A	582002	1	RIGHT HAND MOTOR MOUNT
7B	582004	1	LEFT HAND MOTOR MOUNT
8	523058	4	90 DEGREE MOTOR ADAPTER
9	583462	3	HOSE WHEEL DRIVE SHORT MC 72 (21" LG)
10	583461	1	HOSE WHEEL DRIVE LONG MC 72 (26 3/4" LG)
13	583241	2	PUMP TO PUMP HOSE
16	453129	1	PUMP TO TANK SUPPLY HOSE
17	453106	2	SWIVEL TEE
18	583391	2	90 DEGREE INLET ADAPTER
19	583126	4	STRAIGHT ADAPTER
20	453074	2	90 DEGREE ADAPTER
21	453087	2	PUMP-V (10L)
21A	453146	X	PUMP SEAL KIT - (10L)
22	583382	2	PUMP PULLEY
23	423178	2	TAPER HUB
24	453102	2	PUMP KEY
25	100252	2	1/4"-20 X 3/4" HEX BOLT
26	823104	2	CONTROL BAR
27	100257	4	1/4"-20 X 1 3/4" HEX BOLT
28	453090	2	CLAMP BAR
29	104255	6	1/4"-20 NYLOC NUT
30	583132	1	SUCTION SCREEN
31	583442	1	FILTER ADAPTER(61" & 72")
32	423064	1	FILTER HEAD
33	423063	1	HYDRO OIL FILTER (NO CROSS REF AVAIL)
34	423165	1	OIL BREATHER CAP(61" & 72")
35	583049	1	OIL TANK(61" & 72")
36	423065	1	OIL EYE
37	583217	1	PUMP DRIVE PULLEY
38	583385	1	PUMP BELT
39A	583042	1	RIGHT HAND BRAKE ROD(61" & 72")
39B	583044	1	LEFT HAND BRAKE ROD(61" & 72")
40	422049	1	BRAKE CRANK
41	373086	1	SPACER
42	104256	6	5/16" PUSH NUT
43	104256	20	5/16" NYLOC NUT
44	105258	2	5/16" FLAT WASHER
45	523024	2	SPRING
46	423130	2	PARK BRAKE SWIVEL
47	423112	2	5/16" CLAMP COLLAR
48	363177	2	3/8" PUSH NUT

72" Mid-Cut Small Hydro Pump Assembly

#	PART NO.	QTY	DESCRIPTION
49	583460	2	BRAKE ARM
50A	583038	1	RIGHT HAND BRAKE CALIPER
50B	583039	1	LEFT HAND BRAKE CALIPER
50C	583511	X	BRAKE PAD KIT
51	583040	2	CALIPER MOUNT
52	100343	8	1/2"-13 X 9" HEX BOLT
53	100300	2	3/8"-16 X 3" HEX BOLT
54	104257	32	3/8" NYLOC NUT
56	583328	1	PUMP PLATE
58	105260	13	3/8" FLAT WASHER
59	823351	1	FLAT IDLER
60	523277	1	IDLER SPACER
61	422025	1	TENSIONER W/BUSHING
61A	523111	X	BUSHING (SERVICE)
62	107501	2	3/8"-16 X 2" CARRIAGE BOLT
65	373089	2	RETAINING WASHER
66	393070	1	IDLER PIVOT
68	583144	1	PUMP IDLER SPRING
70	109007	2	3/8"-16 WHIZLOCK NUT
71	523277	1	SPACER
73	583274	1	FRONT DRIVE ADAPTER

72" Mid-Cut Electrical Section - Gas

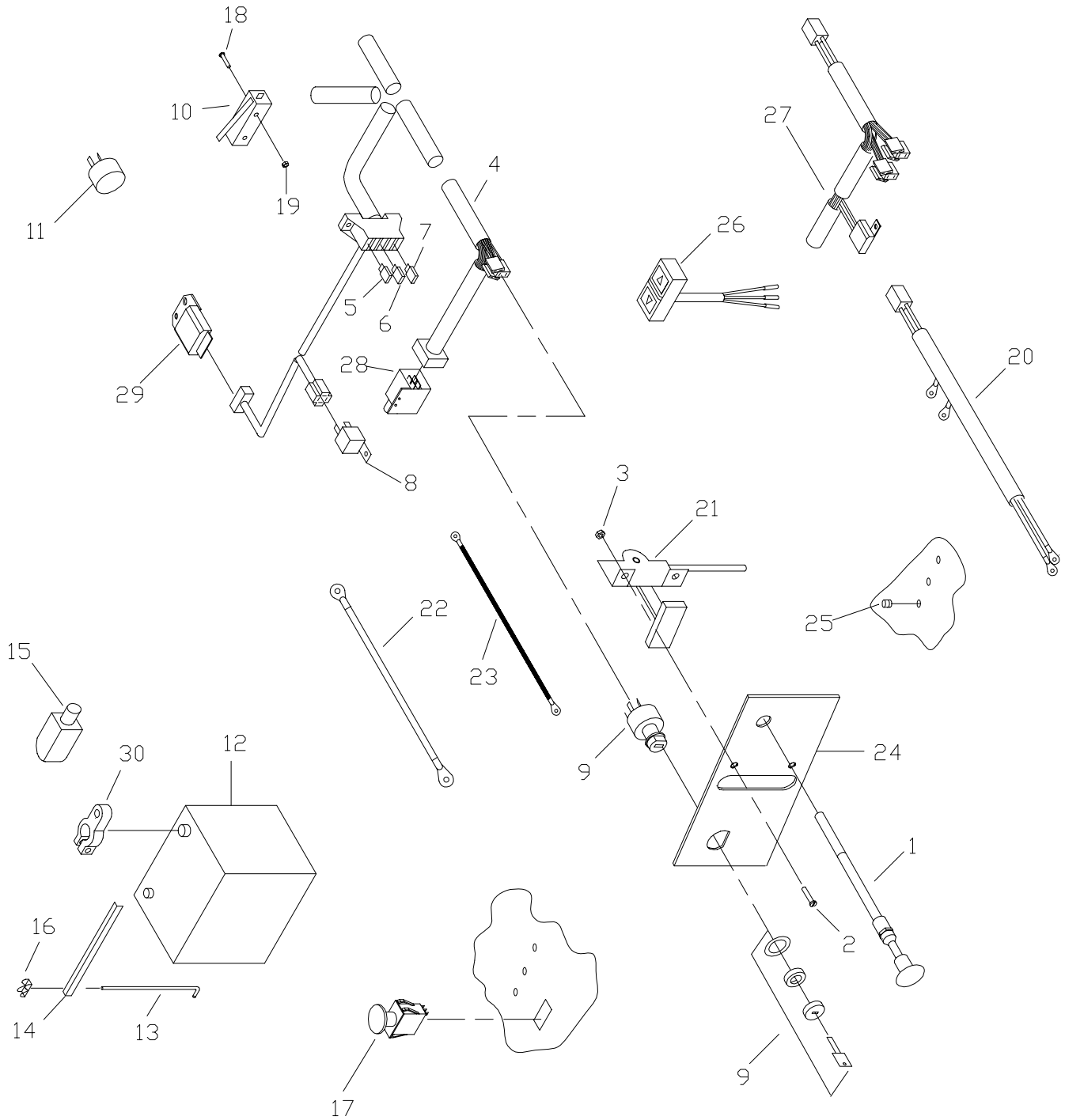

72" Mid-Cut Electrical Section - Gas

27 HP KAW
31 HP BRIGGS

#	PART NO.	QTY	DESCRIPTION	27 HP KAW	31 HP BRIGGS
1	583161	1	CHOKE CABLE - IL3G		X
1A	523037	1	CHOKE CABLE	X	
2	101039	6	#10-24 X 5/8" PAN HEAD BOLT		
3	104252	6	#10-24 NYLOC NUT		
4A	583317	1	WIRE HARNESS 950G-MC		X
4B	583484	1	WIRE HARNESS	X	
5	583502	1	30 AMP FUSE		
6	523146	1	15 AMP FUSE		
7	523147	1	10 AMP FUSE		
8	523042	3	RELAY		
9	423027	1	IGNITION SWITCH ASSEMBLY		
10	823193	1	NEUTRAL SWITCH		
11	823194	1	ALARM		
12	523050	1	12 VOLT BATTERY		
13	423172	2	BATTERY HOLD DOWN		
14	583403	1	BATTERY ANGLE - IL3		
15	583409	1	POSITIVE BATTERY BOOT		
16	109017	2	1/4"-20 WING NUT		
17	523031	1	PTO SWITCH		
18	101252	2	#5-40 X 1" SCREW		
19	104520	2	#5-40 NUT		
20	583319	1	ENGINE WIRE HAR.-950G	X	
21	583057	1	THROTTLE CONTROL		X
21A	523038	1	THROTTLE CONTROL	X	
22	823196	1	POSITIVE CABLE		
23	823197	1	NEGATIVE CABLE		
24	583037	1	CONTROL PANEL		
25	523036	4	WARNING LIGHT		
26	583411	1	ELECTRIC LIFT SWITCH		
27	583412	1	ELECTRIC LIFT HARNESS		
28	523034	1	PARK SWITCH		
29	583423	1	TIME DELAY MODULE		
30	583429	2	BATTERY TERMINAL		
31	423030	1	SAFETY MODULE	X	
32	583351	2	ELECTRIC LIFT RELAY (5 PRONG)		
33	583238	1	RELAY MOUNT		

**72" MID-CUT
DIESEL ENGINE
OPTION
SECTION**

72" Mid-Cut Deck Assembly

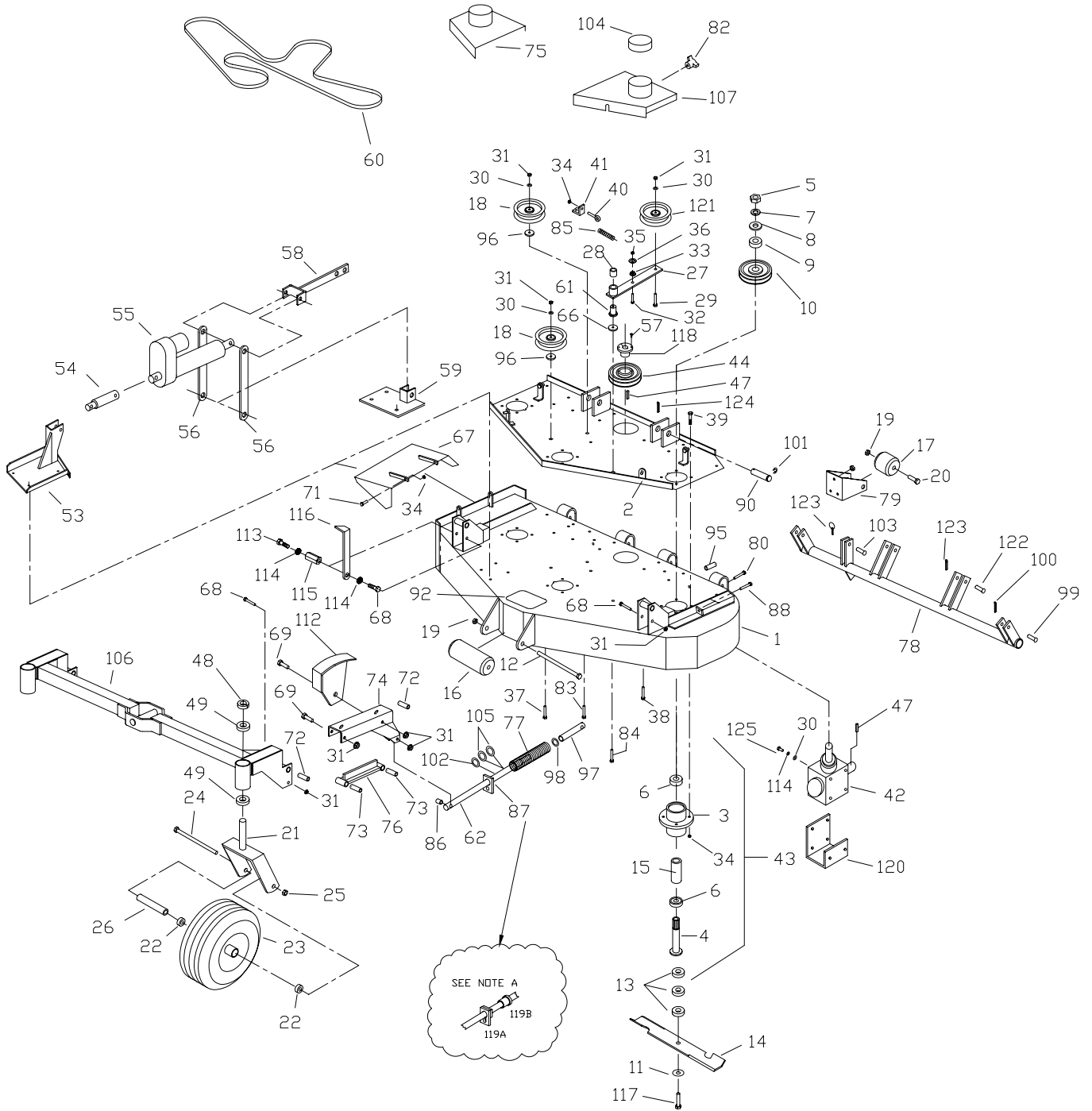

72" Mid-Cut Deck Assembly

#	PART NO.	QTY	DESCRIPTION
1	582096	1	72" MC DECK WELDMENT
2	582098	1	72" DECK CHANNEL
3	583111	3	SPINDLE HOUSING
4	583112	3	SPINDLE SHAFT
5	104511	3	3/4"-16 HEX NUT
6	363350	6	BEARING - BLADE SPINDLE
7	105010	3	3/4" LOCK WASHER
8	105269	3	3/4" SAE FLAT WASHER
9	583110	3	PULLEY SPACER
10	583107	3	PULLEY - SPINDLE 5 3/4"
11	583108	3	5/8" SPRING DISC WASHER
12	100351	1	5/8"-11 X 8 1/2" HEX BOLT
13	583109	9	BLADE SPACER
14	583287	3	25" OFFSET BLADE
15	583113	3	BEARING SPACER TUBE
16	603023	1	ANTI-SCALP ROLLER
17	523084	2	REAR DECK ROLLER
18	583162	2	6" FLAT IDLER
19	104261	3	5/8"-11 NYLOC NUT
20	100346	2	5/8"-11 X 4 1/2" HEX BOLT
21	822088	2	WIDE TAIL WHEEL STRUT
22	363187	4	1" BEARING
23	823220	2	WIDE TAIL WHEEL (COMPLETE)
23A	823339	X	TIRE (13 X 6.5 X 6)
23B	823338	X	FRONT RIM W/ VALVESTEM
24	100352	2	5/8"-11 X 9" HEX BOLT
25	104261	2	5/8"-11 NYLOC NUT
26	823245	2	AXLE TUBE (WTW)
27	822144	1	DECK IDLER ARM W/BUSHING
28	363007	1	3/4" FLANGE BUSHING
29	107511	1	3/8"-16 X 2" CARRIAGE BOLT
30	105260	8	3/8" FLAT WASHER
31	104257	16	3/8"-16 NYLOC NUT
32	100275	1	5/16"-18 X 1 1/2" HEX BOLT
33	109001	2	5/16"-18 WHIZLOCK NUT
34	104256	36	5/16"-18 NYLOC NUT
35	109007	2	3/8"-16 WHIZLOCK NUT
36	105258	9	5/16" FLAT WASHER
37	107503	10	5/16"-18 X 3/4" CARRIAGE BOLT
38	107509	5	5/16"-18 X 1" CARRIAGE BOLT
39	100274	12	5/16"-18 X 1 1/4" HEX BOLT
40	363080	1	EYEBOLT - RIGHT
41	523094	1	SPRING MOUNT - DECK
42	583166	1	GEAR BOX LARGE
43	583106	3	BLADE SPINDLE ASSY
44	583447	1	6" TAPER LOCK SHEAVE
46	105005	4	5/16" LOCK WASHER
47	107255	1	3/16" X 1" KEY
48	363145	2	1" CLAMP COLLAR
49	363187	2	1" FLANGE BEARING

72" Mid-Cut Deck Assembly

#	PART NO.	QTY	DESCRIPTION
53	582182	1	MC LIFT RISER WELDMENT
54	583236	1	ACTUATOR EXTENSION
55	583294	1	ELECTRIC ACTUATOR
56	583499	2	E.L. PIVOT ARM
57	100252	6	1/4"-20 X 3/4" HEX BOLT
58	582217	1	E.L. RAM WELDMENT
59	582215	1	E.L. PIVOT MOUNT WELDMENT
60	583153	1	72" DECK BELT
61	423175	1	PUMP IDLER PIVOT
62	583474	2	CASTER ROD
66	373089	1	3/8" RETAINING WASHER
67	582108	1	DEFLECTOR SHIELD 72"
68	100300	4	3/8"-16 X 3" HEX BOLT
69	100301	4	3/8"-16 X 3 1/4" HEX BOLT
71	100273	2	5/16"-18 X 1" HEX BOLT
72	823330	4	CASTER ARM PIVOT
73	823090	4	CASTER BAR PIVOT
74A	582053	1	LEFT HAND CASTER ARM
74B	582051	1	RIGHT HAND CASTER ARM
75	582100	1	RIGHT HAND BELT SHIELD
76	582059	2	CASTER BAR WELDMENT
77	823150	2	SPRING
78	582112	1	72" DECK TUBE WELDMENT
79	583074	2	ROLLER MOUNT
80	100298	2	3/8"-16 X 2 1/2" HEX BOLT
82	753028	4	KNOB
83	107516	2	3/8" X 2 1/4" CARRIAGE BOLT
84	107513	3	3/8"-16 X 3" CARRIAGE BOLT
85	593074	1	FLOATING IDLER SPRING
86	823153	2	SPACER - DECK
87	823159	2	SPRING SLIDE
88	100030	2	3/8"-16 X 3" TAP BOLT
90	823333	2	DECK ATTACH PIN
91	108001	3	3/16" QUICK PIN
92	823200	1	STEP TREAD
95	823314	2	TUBE SADDLE SPACER
96	483017	2	RIGHT HAND IDLER SPACER
97	583472	2	CASTER ROD END
98	109025	2	5/8" HEAVY WASHER
99	823210	2	1/2" X 2" CLEVIS PIN
100	106763	2	1/8" COTTER PIN
101	108510	4	7/8" E-RING
102	373078	2	CASTER SHIM WASHER
103	823209	2	1/2" X 1 1/2" CLEVIS PIN
104	363161	3	BELT SHIELD CAP
105	583393	4	DECK ROD WASHER
106	582090	1	FRONT AXLE - 72MC
108	582102	1	BELT SHIELD LEFT HAND 72"
111	582176	1	CUT GAGE WELDMENT

72" Mid-Cut Deck Assembly

#	PART NO.	QTY	DESCRIPTION
113	100291	1	3/8"-16 X 3/4" HEX BOLT
114	105006	2	3/8" LOCKWASHER
115	583422	1	NUT-CUT GAGE
116	583420	1	POINTER CUT GAGE
117	100347	3	5/8"-11 X 2" HEX BOLT
118	363215	1	1" TAPER LOCK HUB
119A	592006	1	SPRING RETAINER
119B	363007	1	FLANGE BUSHING
120	593096	1	GEAR BOX TRUSS
121	523329	1	FLOATING IDLER - FLAT
122	823211	2	1/2" X 2 1/2" RING PIN
123	106778	3	3/16" X 1 1/2" COTTER PIN
124	108001	2	3/16" QUICK PIN
125	100293	4	3/8"-16 X 1 1/4" HHCS

NOTES:

- A PERFORMANCE UPGRADE FOR DECK SPRING ASSY. REQUIRES ITEM 119. BOTH SIDES NEED BE UPGRADED AT THE SAME TIME.

72" Mid-Cut Mainframe Assembly

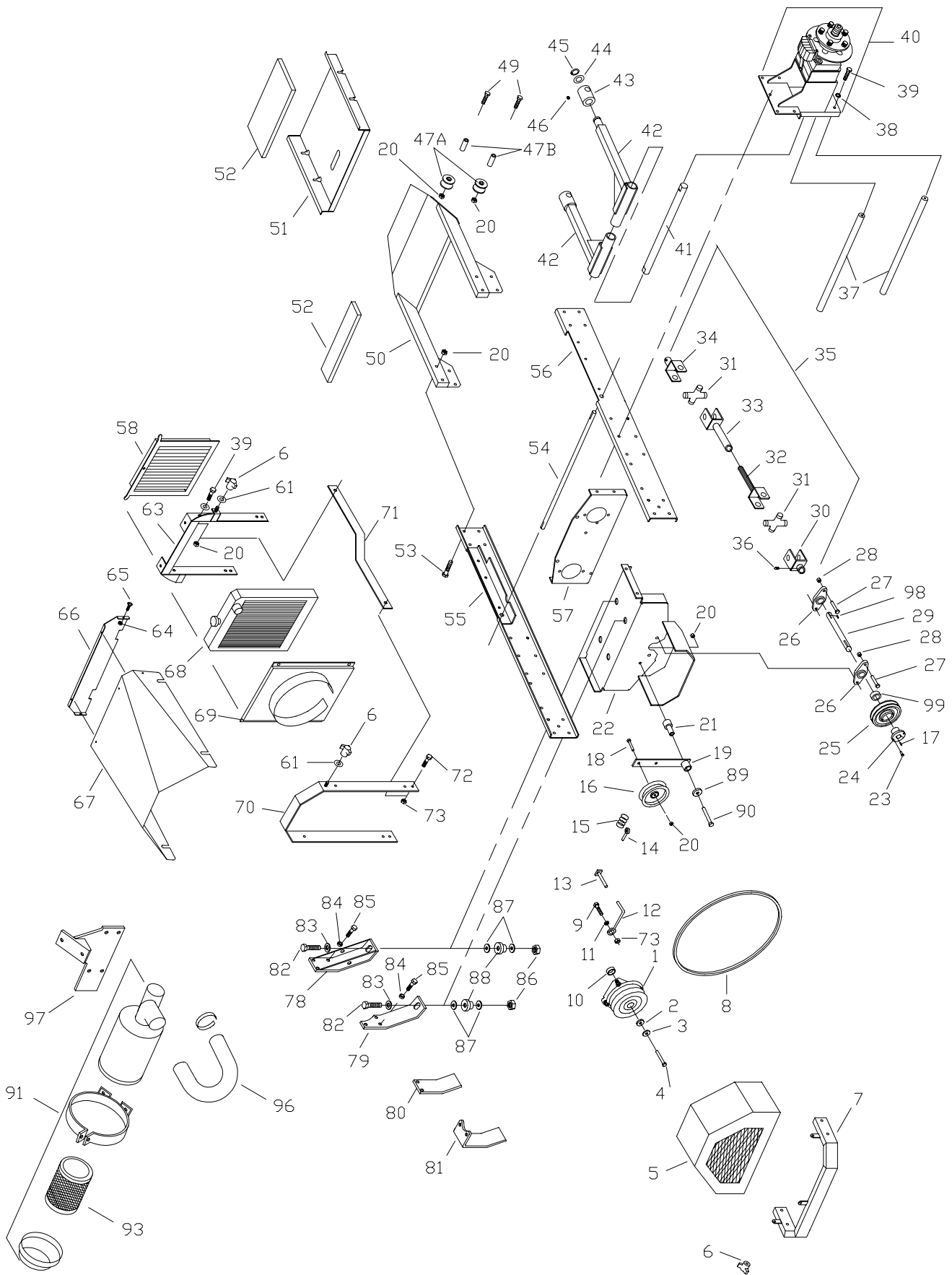

72" Mid-Cut Mainframe Assembly

#	PART NO.	QTY	DESCRIPTION
1	583308	1	CLUTCH - 200 FT/LBS
2	373089	1	RETAINER WASHER
3	423069	2	7/16" SPRING DISC WASHER
4	100534	1	7/16"-20 X 1 1/4" HEX BOLT
5	582157	1	CLUTCH COVER - IL3
6	753028	7	KNOB
7	582132	1	ENGINE GUARD
8	523374	1	CLUTCH BELT
9	100273	16	5/16"-18 X 1" HEX BOLT
10	823248	2	CLUTCH SPACER 9/32
11	105258	6	5/16" FLAT WASHER
12	363075	1	ROUND BELT GUIDE
13	582169	1	CLUTCH STOP
14	363080	1	RIGHT EYE BOLT
15	593074	1	IDLER SPRING HH
16	483025	1	RIGHT HAND IDLER PULLEY
17	107259	1	1/4" X 1/4" X 1" KEY
18	100294	6	3/8"-16 X 1 1/2" HEX BOLT
19	422025	1	TENSIONER W/BUSHING
19A	523111	X	BUSHING (SERVICE)
20	104257	32	3/8"-16 NYLOC NUT
21	823030	1	PUMP IDLER SUPPORT
22	582165	1	ENGINE BASE 26 DSL MC
23	100503	2	1/4" X 3/4" HEX BOLT
24	363215	1	TAPER LOCK HUB
25	363216	1	TAPER LOCK SHEAVE
26	823032	2	2-BOLT FLANGE BEARING
27	100311	4	7/16"-14 X 1 1/4" HEX BOLT
28	104258	4	7/16"-14 NYLOC NUT
29	583271	1	POWER SHAFT - MC - DSL
30	523414	1	1" YOKE
31	523415	2	CROSS & BEARING
32	593075	1	YOKE SHAFT
33	583481	1	YOKE TUBE
34	823372	1	3/4" YOKE
35	593064	1	DRIVE SHAFT MC
36	103295	2	3/8"-16 X 1/2" SET SCREW
37	823066	2	BRACE ROD - LOWER
38	105006	6	3/8" LOCK WASHER
39	100292	23	3/8"-16 X 1" HEX BOLT
40			SEE HYDRAULIC ILLUSTRATION
41	823050	1	DECK ARM SHAFT
42	822036	2	DECK ARM
43	822090	2	DECK SWIVEL W/ZERK
44	823015	4	DECK ARM WASHER
45	108502	2	SNAP RING
46	111004	12	1/4"-28 GREASE ZERK
47	583464	2	FRONT ROLLER - MC (REF ONLY)
47A	583464	2	FRONT ROLLER
47B	583490	2	FRONT ROLLER TUBE
49	100298	2	3/8"-16 X 2 1/2" HEX BOLT
50	582092	1	FRONT FRAME

72" Mid-Cut Mainframe Assembly

#	PART NO.	QTY	DESCRIPTION
51	582094	1	FOOT PLATE
52	583374	1	FOOT REST PAD LARGE
52	583373	1	FOOT REST PAD SMALL
53	100295	4	3/8"-16 X 1 3/4" HEX BOLT
54	823140	1	PARK SHAFT
55	582124	1	LEFT HAND FRAME RAIL
56	582126	1	RIGHT HAND FRAME RAIL
57			SEE HYDRAULIC ILLUSTRATION
58	583301	1	RADIATOR SCREEN
61	105260	13	3/8" FLAT WASHER
63	582159	1	RADIATOR MOUNT
64	104252	15	#10-24 NYLOC NUT
65	101039	17	#10-24 X 5/8" SCREW
66	583010	1	FRONT ENGINE COVER - IL3
67	583296	1	ENGINE COVER
68	SEE NOTE A	1	RADIATOR ASSY.
69	583476	1	FAN SHROUD
70	582161	1	HOOD BRACE
71	583356	2	HOOD SIDE BRACE
72	100271	4	5/16"-18 X 3/4" HEX BOLT
73	104256	5	4/16"-18 NYLOC NUT
78	583250	2	ENGINE MOUNT FRONT
79	582116	2	ENGINE MOUNT - 3 CYL.
80	582151	1	FUEL PUMP MOUNT
81	582134	1	FUEL FILTER MOUNT
82	100327	4	1/2"-13 X 1 1/2" HEX BOLT
83	105264	4	1/2" FLAT WASHER
84	105005	6	5/16" LOCK WASHER
85	109031	6	M8-1.25 X 20MM HEX BOLT
86	104259	4	1/2"-13 NYLOC NUT
87	583478	8	WASHER-ISO MOUNT
88	583303	4	ISO BUSHING
89	373089	1	RETAINING WASHER
90	100300	2	3/8"-16 X 3" HEX BOLT
91	583364	1	AIR CLEANER ASSY 90 DEGREE
93	583298	1	AIR FILTER ELEMENT
96	583369	1	AIR FILTER HOSE U-SHAPE
97	582153	1	AIR FILTER MOUNT
98	107258		POWER SHAFT KEY
99	363145	1	1" CLAMP COLLAR

NOTE:

A CONTACT ENGINE MFG FOR ALL ENGINE & RADIATOR PARTS NOT SHOWN. **ENCORE MFG DO NOT SERVICE THESE PARTS!**

72" Mid-Cut Seat Frame Assembly

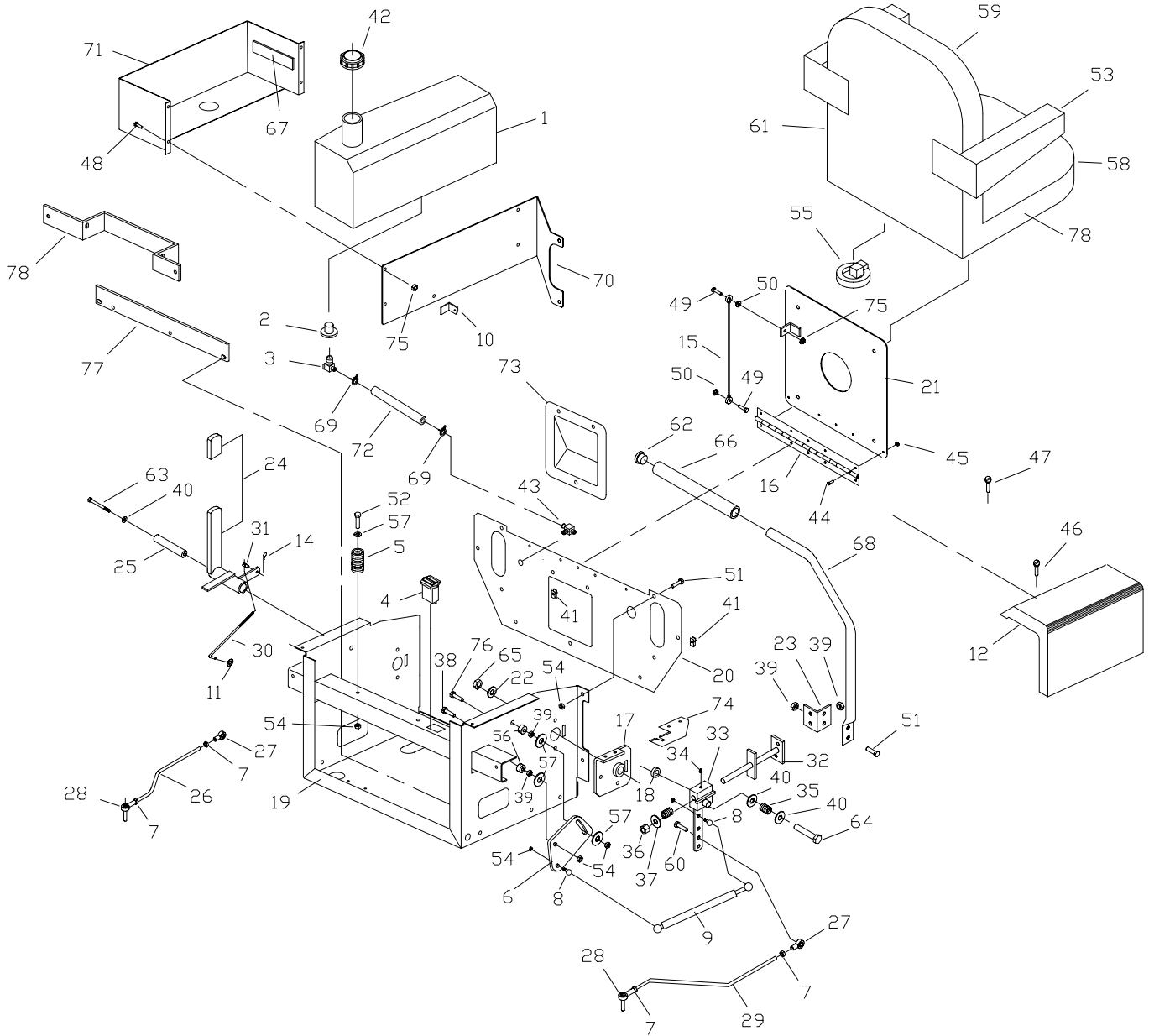

72" Mid-Cut Seatframe Assembly

#	PART NO.	QTY	DESCRIPTION
1	583154	2	FUEL TANK - MC
2	393042	4	GROMMET
3	583183	4	FUEL TANK ADAPTER
4	523283	1	HOUR METER
5	523278	2	SEAT SPRING
6	583438	2	ADJUSTMENT PLATE
7	104752	4	5/16"-24 JAM NUT
8	823221	4	10MM BALL STUD
9	583415	2	DAMPENER CONTROL
10	583046	2	BACK PLATE TAB
11	153045	2	5/16" PUSH NUT
12A	583065	1	RIGHT FENDER
12B	583064	1	LEFT FENDER
14	363165	1	HAIR PIN COTTER
15	523044	1	SEAT CABLE
16	523105	1	SEAT HINGE
17A	582110	1	LEFT HAND PIVOT W/BUSHING
17B	582109	1	RIGHT HAND PIVOT W/BUSHING
18	253059	2	ENGAGEMENT BUSHING
19	822054	1	SEAT FRAME WELDMENT
20	583028	1	FRONT - SEAT FRAME
21	822058	1	SEAT PLATE
22	373089	2	RETAINING WASHER
23	523222	2	CONTROL LEVER ANG.E
24	582048	1	PARK LEVER W/GRIP
25	363105	1	IDLER BUSHING
26	583140	1	PUMP CONTROL LINK - LH
27	453082	2	5/16"-24 ROD END - MALE
28	423160	2	5/16" ROD END MALE
29	583138	1	PUMP CONTROL LINK - RH
30	823132	1	PARK BRAKE LINK
31	363029	2	5/16" ROD SWIVEL
32A	582084	1	LH NEUTRAL LOCK PIVOT
32B	582082	1	RH NEUTRAL LOCK PIVOT
33	822075	2	DRIVE BLOCK W/ZERK
34	111004	2	1/4"-24 ZERK
35	363024	4	COMPRESSION SPRING
36	104259	4	1/2"-13 NYLOC NUT
37	105264	2	1/2" FLAT WASHER
38	100275	2	5/16"-18 X 1 1/2" HEX BOLT
39	109001	8	5/16"-18 WHIZLOCK NUT
40	105260	6	3/8" FLAT WASHER
41	109015	8	1/4"-20 NUT CLIP
42	583463	2	DIESEL FUEL CAP - LARGE
43	583302	1	FUEL VALVE - DIESEL
44	101039	5	#10-28 X 5/8" SCREW
45	104252	4	#10-28 NYLOC NUT
46	103004	2	1/4"-14 X 3/4" SCREW
47	102000	7	#12-24 CUTTING SCREW
48	100252	8	1/4"-20 X 3/4" HEX BOLT

72" Mid-Cut Seatframe Assembly

#	PART NO.	QTY	DESCRIPTION
49	100004	8	1/4"-20 X 1" HEX BOLT
50	109000	8	1/4"-20 WHIZLOCK NUT
51	100271	8	5/16"-18 X 3/4" HEX BOLT
52	100273	2	5/16"-18 X 1" HEX BOLT
53	583091	2	ARM REST PAD KIT
54	104256	20	5/16"-24 NYLOC NUT
55	523030	1	SEAT SWITCH
56	363113	4	WHEEL PULLEY SPACER
57	105258	11	5/16" FLAT WASHER
58	583089	1	SEAT CUSHION
59	583090	1	BACK CUSHION
60	100274	2	5/16"-18 X 1 1/4" HEX BOLT
61	583077	1	SEAT
62	523033	2	HANDLE PLUG
63	100303	1	3/8"-16 X 4" HEX BOLT
64	100305	2	3/8"-16 X 4 1/2" HEX BOLT
65	104257	3	3/8"-16 NYLOC NUT
66	523032	2	HANDLE GRIP
67	363201	4	TANK PAD
68A	523017	2	HANDLE W/O GRIP & PLUG
68B	522100	2	HANDLE COMPLETE W/GRIP & PLUG
69	363098	10	FUEL LINE CLAMP
70A	583054	1	TANK BACK PLATE - LH
70B	583052	1	TANK BACK PLATE - RH
71A	582065	1	FUEL TANK SADDLE LEFT HAND
71B	582045	1	FUEL TANK SADDLE RIGHT HAND
72A	583186	1	FUEL LINE LEFT HAND
72B	583185	1	FUEL LINE RIGHT HAND
73	583037	1	CONTROL PANEL
74A	583254	1	RIGHT HAND LEVER LOCK
74B	583256	1	LEFT HAND LEVER LOCK
75	104255	2	1/4"-20 NYLOC NUT
76	107520	2	5/16"-18 X 3/4" HEX BOLT
78	583401	1	BATTERY MOUNT - 31 GAS/27 DIESEL ONLY
79	583519	1	FULL SUSPENSION SEAT

72" Mid-Cut Large Hydro Pump Assembly

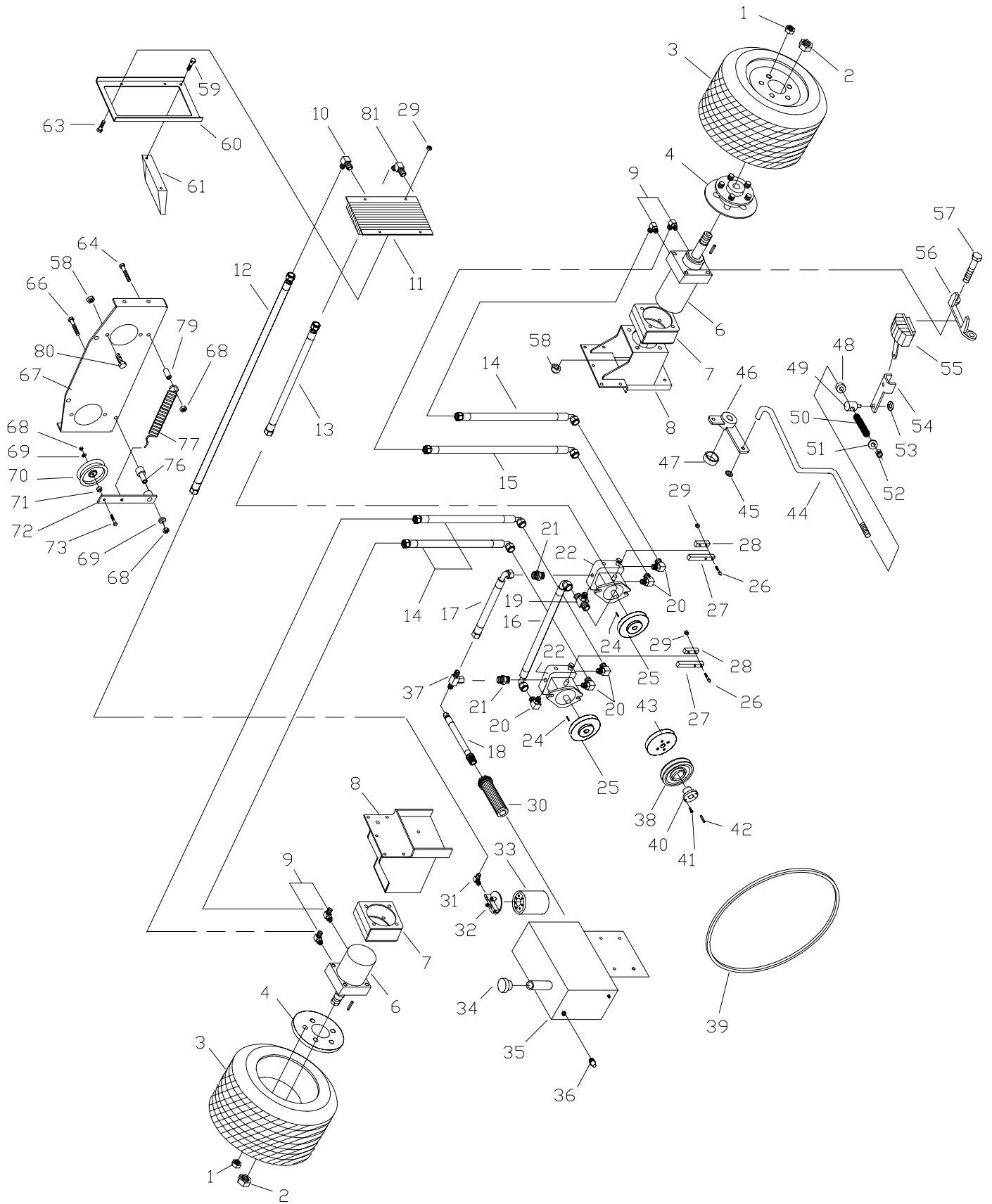

72" Mid-Cut Hydraulic Assembly (21L Series)

#	PART NO.	QTY	DESCRIPTION
1	103023	10	1/2" LUG NUT
2	104511	2	3/4"-16 HEX NUT
3	583055	2	DRIVE WHEEL ASSY (COMPLETE)
3A	583059	X	DRIVE TIRE (24 X 12 X 12)
3B	583487	X	BAR LUG TIRE (23 X 10.5 X 12)
3C	583058	X	RIM W/ VALVESTEM
4	582008	2	WHEEL HUB
6	583022	2	LARGE WHEEL MOTOR - MP24
6A	583520	X	SEAL KIT - MP24
7	582031	4	MOTOR SPACER
8A	582002	1	RIGHT HAND MOTOR MOUNT
8B	582004	1	LEFT HAND MOTOR MOUNT
9	523058	4	RETURN ADPT.
10	583214	2	OIL COOLER ADAPTER
11	583201	1	OIL COOLER
12	583216	1	COOLER TO FILTER HOSE
13	583215	1	PUMP TO COOLER HOSE
14	583461	3	21" HOSE
15	583462	1	26 3/4" HOSE
16	583124	1	PUMP TO PUMP RETURN HOSE
17	583131	1	PUMP TO PUMP SUPPLY HOSE
18	583130	1	TANK TO PUMP SUCTION HOSE
19	583127	1	SUPPLY TEE
20	453113	5	PUMP ELBOW
21	583126	2	STRAIGHT ADAPTER
22	583081	2	LARGE V-PUMP (BDP-21LH)
22A	583377		PUMP SEAL KIT - (BDP-21LH)
24	453102	2	PUMP KEY (5MM)
25	583092	2	PUMP PULLEY
26	100257	4	1/4"-20 X 1 3/4" HEX BOLT
27	823104	2	PUMP CONTROL BAR
28	453090	2	CLAMP BAR
29	104255	6	1/4"-20 NYLOC NUT
30	583132	1	SUCTION SCREEN
31	583129	1	FILTER ADAPTER
32	423064	1	FILTER HEAD
33	423063	1	HYDRO OIL FILTER (NO CROSS REF AVAIL)
34	423165	1	OIL BREATHER CAP
35	583049	1	OIL TANK
36	423065	1	OIL EYE
37	523128	1	TENSIONER SWIVEL
38	583217	1	PUMP DRIVE PULLEY (ENGINE)
39	823026	1	PUMP BELT
40	363215	1	TAPER LOCK HUB
41	100252	2	1/4"-20 X 3/4" HEX BOLT
42	107258	2	1/4" X 1/4" X 3/4" KEY
43	583274	1	FRONT DRIVE ADAPTER
44A	583042	1	RIGHT HAND BRAKE ROD
44B	583044	1	LEFT HAND BRAKE ROD
45	153045	3	5/16" PUSH NUT

72" Mid-Cut Hydraulic Assembly (21L Series)

#	PART NO.	QTY	DESCRIPTION
46	422049	1	BRAKE CRANK
47	373086	1	BLADE SPACER
48	523112	2	5/16" CLAMP COLLAR
49	423130	2	PARK BRAKE SWIVEL
50	523024	2	DECK DR. SPRING
51	105258	2	5/16" FLAT WASHER
52	104256	20	5/16" NYLOC NUT
53	363177	2	3/8" PUSH NUT
54	583460	2	BRAKE ARM
55A	583038	1	RIGHT HAND BRAKE CALIPER
55B	583039	1	LEFT HAND BRAKE CALIPER
55C	583511	X	BRAKE PAD KIT
56	583040	2	CALIPER MOUNT BRACKET
57	100343	8	1/2"-13 X 9" HEX BOLT (72")
58	104261	12	1/2"-13 NYLOC NUT
59	100273	16	5/16"-18 X 1" HEX BOLT
60	583204	1	OIL COOLER CHANNEL
61	582167	1	OIL COOLER MOUNT - 3 CYL
63	100252	6	1/4"-20 3/4" HEX BOLT
64	100300	2	3/8"-16 X 3" HEX BOLT
66	100303	2	3/8"-16 X 4" HEX BOLT
67	582076	1	PUMP PLATE
68	104257	32	3/8" NYLOC NUT
69	105260	13	3/8" FLAT WASHER
70	823351	1	PUMP DRIVE IDLER
71	523277	1	IDLER SPACER
72	422025	1	TENSIONER W/BUSHING
72A	523111	X	BUSHING (SERVICE)
73	107501	2	3/8"-16 X 2" CARRIAGE BOLT
76	823030	2	PUMP IDLER SUPPORT
77	583144	1	PUMP IDLER SPRING
79	393070	1	DRIVE IDLER BUSHING
80	100327	4	1/2"-13 X 1 1/2" HEX BOLT
81	583444	1	OIL COOLER ADAPTER 45 DEGREE

72" Hydro Small Pump Assembly

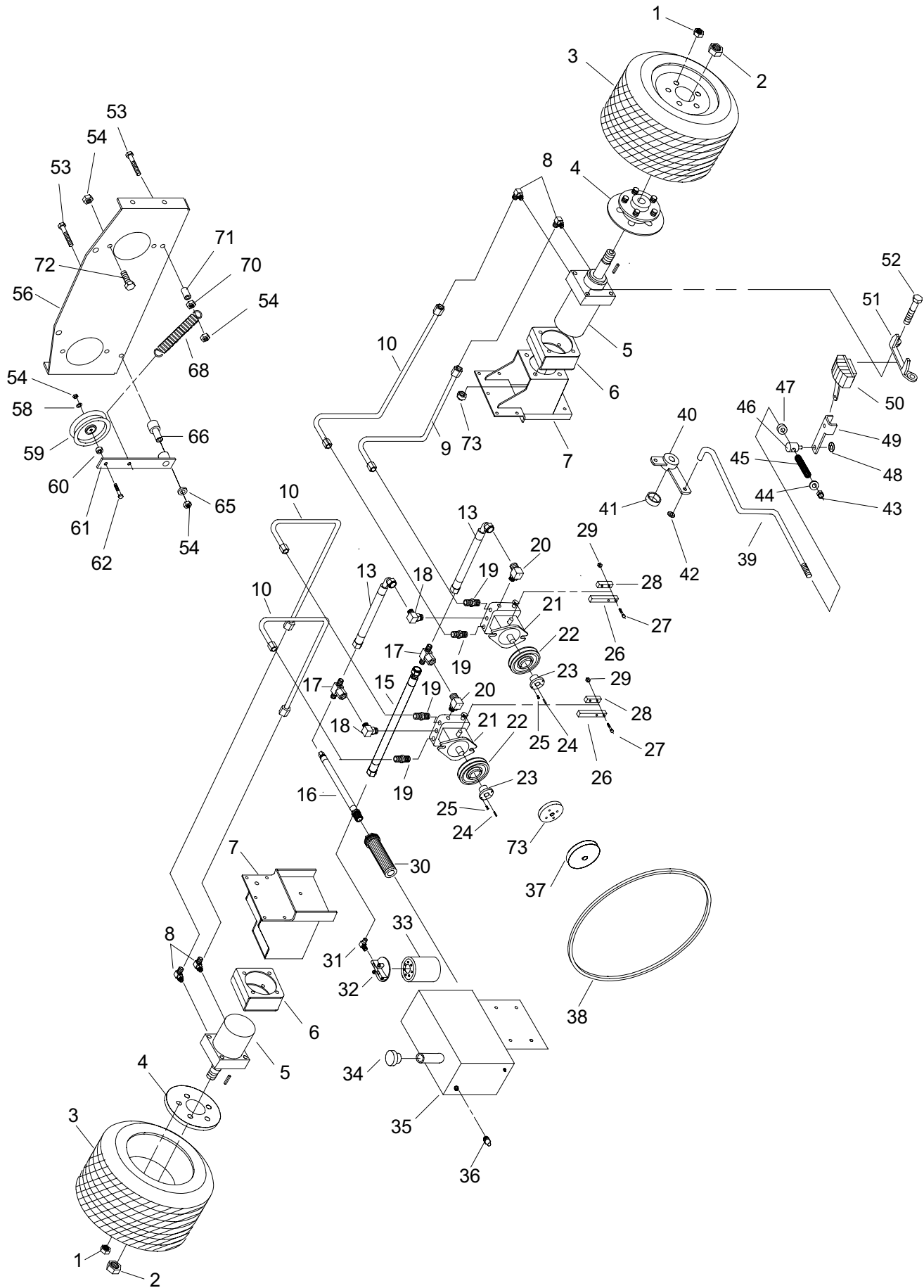

72" Mid-Cut Small Hydro Pump Assembly

#	PART NO.	QTY	DESCRIPTION
1	103023	10	LUG NUT
2	104511	2	WHEEL NUT
3	583055	2	DRIVE WHEEL ASSY (COMPLETE)
3A	583059	X	DRIVE TIRE (24 X 12 X 12)
3B	583487	X	BAR LUG TIRE (23 X 10.5 X 12)
3C	583058	X	RIM W/ VALVESTEM
4	582008	2	WHEEL HUB
5	583325	2	WHEEL MOTOR
6	582031	4	MOTOR SPACER
7A	582002	1	RIGHT HAND MOTOR MOUNT
7B	582004	1	LEFT HAND MOTOR MOUNT
8	523058	4	90 DEGREE MOTOR ADAPTER
9	583462	3	HOSE WHEEL DRIVE SHORT MC 72 (21" LG)
10	583461	1	HOSE WHEEL DRIVE LONG MC 72 (26 3/4" LG)
13	583241	2	PUMP TO PUMP HOSE
16	453129	1	PUMP TO TANK SUPPLY HOSE
17	453106	2	SWIVEL TEE
18	583391	2	90 DEGREE INLET ADAPTER
19	583126	4	STRAIGHT ADAPTER
20	453074	2	90 DEGREE ADAPTER
21	583491	2	PUMP-V (10A)
21A	583377	X	PUMP SEAL KIT - (10A)
22	583382	2	PUMP PULLEY
23	423178	2	TAPER HUB
24	453102	2	PUMP KEY
25	100252	2	1/4"-20 X 3/4" HEX BOLT
26	823104	2	CONTROL BAR
27	100257	4	1/4"-20 X 1 3/4" HEX BOLT
28	453090	2	CLAMP BAR
29	104255	6	1/4"-20 NYLOC NUT
30	583132	1	SUCTION SCREEN
31	583442	1	FILTER ADAPTER (61" & 72")
32	423064	1	FILTER HEAD
33	423063	1	HYDRO OIL FILTER (NO CROSS REF AVAIL)
34	423165	1	OIL BREATHER CAP (61" & 72")
35	583049	1	OIL TANK (61" & 72")
36	423065	1	OIL EYE
37	583217	1	PUMP DRIVE PULLEY
38	583385	1	PUMP BELT
39A	583042	1	RIGHT HAND BRAKE ROD (61" & 72")
39B	583044	1	LEFT HAND BRAKE ROD (61" & 72")
40	422049	1	BRAKE CRANK
41	373086	1	SPACER
42	104256	6	5/16" PUSH NUT
43	104256	20	5/16" NYLOC NUT
44	105258	2	5/16" FLAT WASHER
45	523024	2	SPRING
46	423130	2	PARK BRAKE SWIVEL
47	423112	2	5/16" CLAMP COLLAR
48	363177	2	3/8" PUSH NUT

72" Mid-Cut Small Hydro Pump Assembly

#	PART NO.	QTY	DESCRIPTION
49	583460	2	BRAKE ARM
50A	583038	1	RIGHT HAND BRAKE CALIPER
50B	583039	1	LEFT HAND BRAKE CALIPER
50C	583511	X	BRAKE PAD KIT
51	583040	2	CALIPER MOUNT
52	100343	8	1/2"-13 X 9" HEX BOLT
53	100300	2	3/8"-16 X 3" HEX BOLT
54	104257	32	3/8" NYLOC NUT
56	583328	1	PUMP PLATE
58	105260	13	3/8" FLAT WASHER
59	823351	1	FLAT IDLER
60	523277	1	IDLER SPACER
61	422025	1	TENSIONER W/BUSHING
61A	523111	X	BUSHING (SERVICE)
62	107501	2	3/8"-16 X 2" CARRIAGE BOLT
65	373089	2	RETAINING WASHER
66	393070	1	IDLER PIVOT
68	583144	1	PUMP IDLER SPRING
70	109007	2	3/8"-16 WHIZLOCK NUT
71	523277	1	SPACER
73	583274	1	FRONT DRIVE ADAPTER

72" Mid-Cut Electrical Section

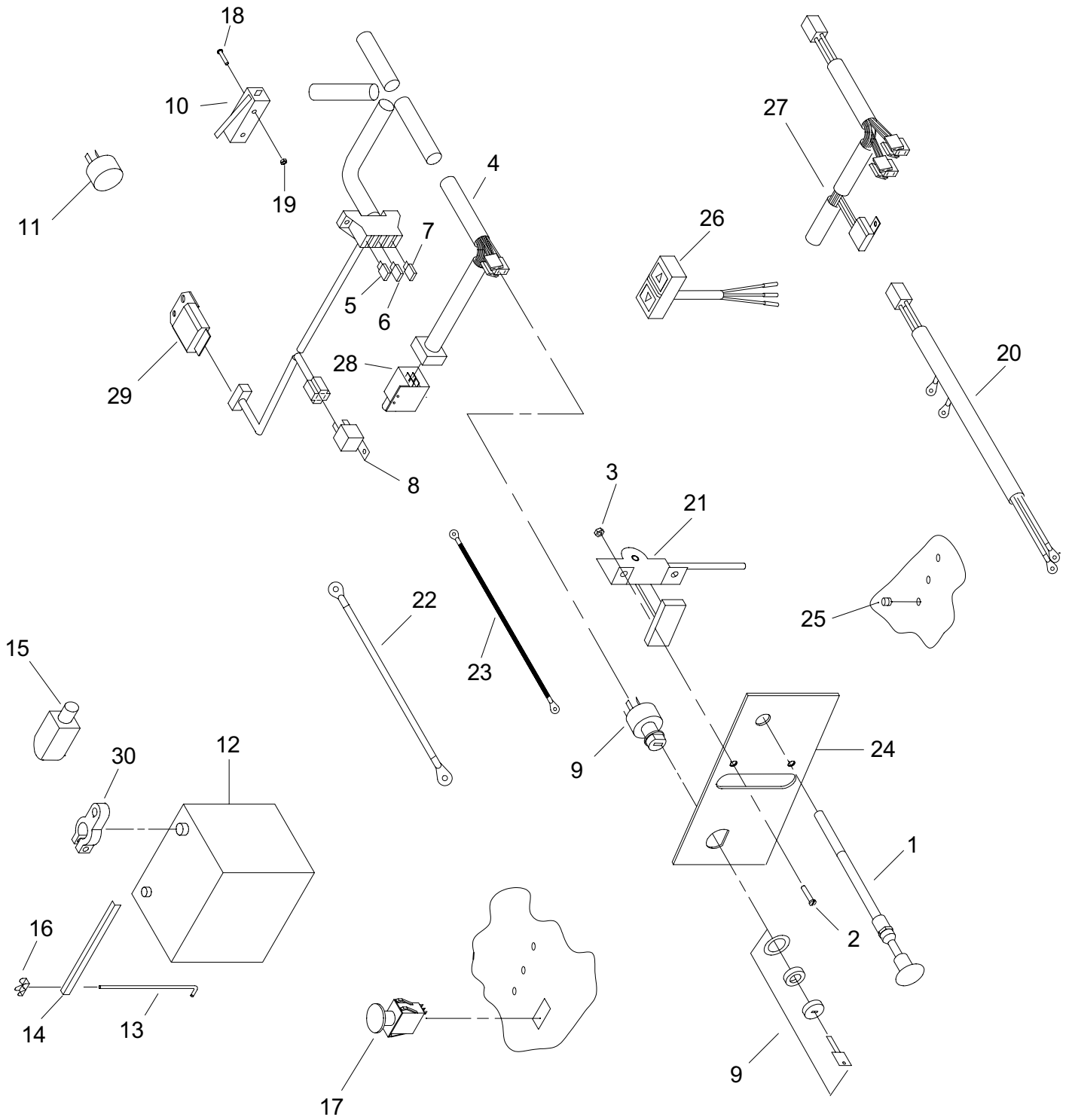

72" Mid-Cut

Electrical Section - Diesel

#	PART NO.	QTY	DESCRIPTION
1	X	X	NOT INSTALLED - CHOKE CABLE
2	101039	6	#10-24 X 5/8" PAN HEAD BOLT
3	104252	6	#10-24 NYLOC NUT
4	583277	1	WIRE HARNESS - 950D-MC
5	583502	1	30 AMP FUSE
6	523146	1	15 AMP FUSE
7	583502	1	30 AMP FUSE
8	523042	3	RELAY
9	423027	1	IGNITION SWITCH ASSEMBLY
10	823193	1	NEUTRAL SWITCH
11	823194	1	ALARM
12	523050	1	12 VOLT BATTERY
13	423172	2	BATTERY HOLD DOWN
14	583403	1	BATTERY ANGLE - IL3
15	583409	1	POSITIVE BATTERY BOOT
16	109017	2	1/4"-20 WING NUT
17	523031	1	PTO SWITCH
18	101252	2	#5-40 X 1" SCREW
19	104520	2	#5-40 NUT
20	583275	1	ENGINE WIRE HARNESS DSL
21	583057	1	THROTTLE CONTROL
22	823196	1	POSITIVE CABLE
23	823197	1	NEGATIVE CABLE
24	583037	1	CONTROL PANEL
25	523036	3	WARNING LIGHT
26	583411	1	ELECTRIC LIFT SWITCH
27	583412	1	ELECTRIC LIFT HARNESS
28	523034	1	PARK SWITCH
29	583423	1	TIME DELAY MODULE
30	583429	2	BATTERY TERMINAL
31	583351	2	ELECTRIC LIFT RELAY (5 PRONG)
32	583238	1	RELAY MOUNT

72" Mid-Cut Decals



1

ENCORE

2,3,4



5



6

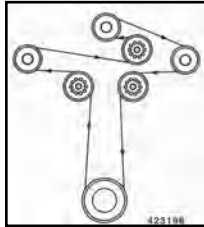

7

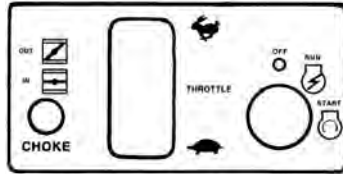

8



9

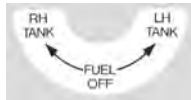

12

PROWLER

14,21



10



11

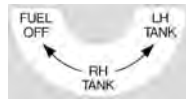

17



18



19

PRO 72

15

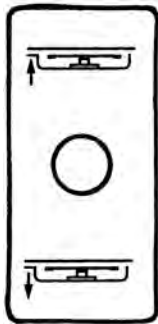

16



23



24

DIESEL

20



25



26

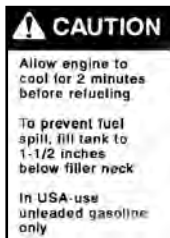

22



28



29



27



30



31

72" Mid-Cut

Decal List

#	PART NO.	DESCRIPTION
1	363023	DANGER DECAL
2	363231	LARGE ENCORE LABEL
3	363243	ENCORE DECAL
4	363265	SMALL ENCORE LABEL
5	423155	RIDER CAUTION DECAL
6	423156	PARK LEVER DECAL
7	423196	BELT ROUTING DECAL
8	423197	CONTROL DECAL
9	453010	OIL DECAL
10	523020	LIGHT DECAL
11	523021	PTO DECAL
12	583023	LABEL – FUEL VALVE - GAS
13	583076	PROWLER DECAL (LARGE CAT DECAL)
14	583088	PROWLER - BLK DECAL
15	583193	PRO-72" DECAL
16	583232	DECAL – UP- DOWN
17	583280	FUEL VALVE LABEL – DSL
18	583372	GLOW PLUG DECAL
19	583416	CUT GAGE DECAL
20	583441	DIESEL LABEL
21	583443	PROWLER DECAL - RED
22	823318	FUEL TANK DECAL
23	823319	TIP OVER – WARNING
24	823320	BATTERY - WARNING DECAL
25	823321	OPERATING - WARNING
26	823322	ROTATING PARTS – DANGER
27	823323	ROTATING PARTS - WARNING
28	823324	SHIELD - DANGER
29	823325	THROWN OBJECTS - DANGER
30	823326	DISCHARGE - WARNING
31	823327	DISCHARGE - DANGER

**72" MID-CUT
ELECTRICAL
SCHEMATIC
SECTION**

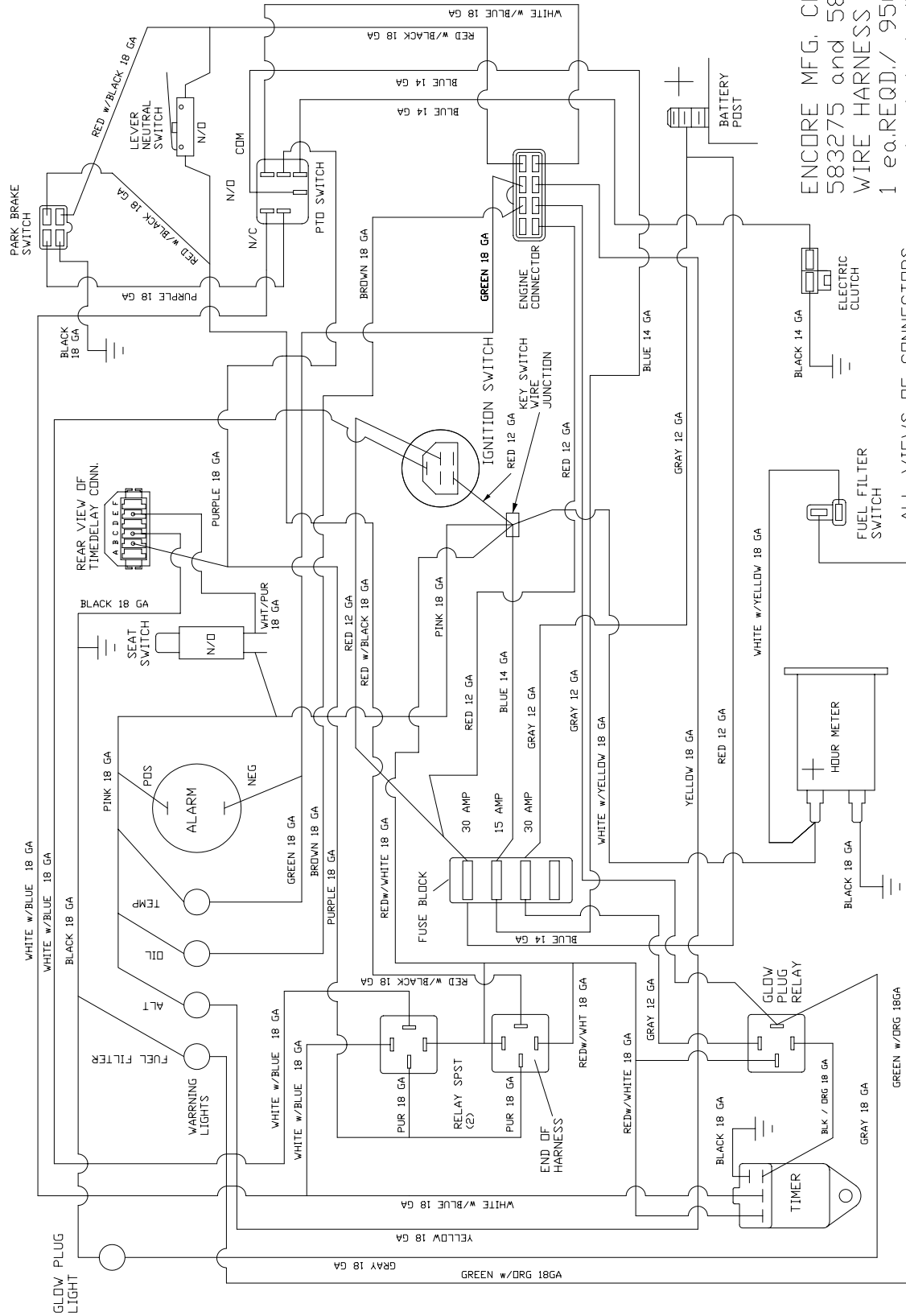

ENCORE MFG. CO., INC.
 583275 and 583277
 WIRE HARNESS
 1 ea. REQD./ 950D FC & MC
 - electrical diagram -

ALL VIEWS OF CONNECTORS
 ARE FROM WIRE-IN SIDE

ENCORE MFG. CO., INC.
 583276 ENGINE WIRE
 HARNESS
 1 REQD./ 950D
 - electrical diagram -

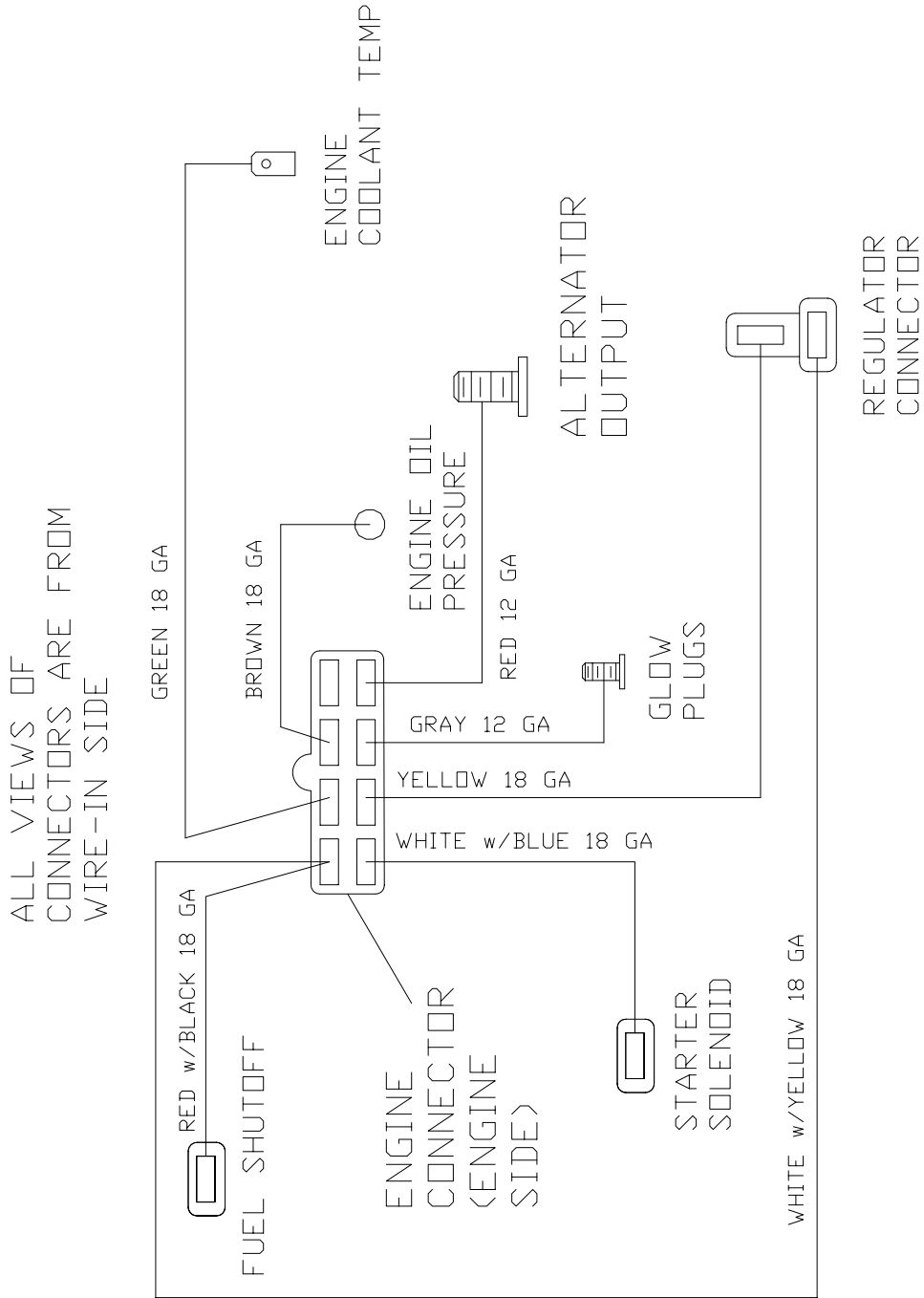

ENCORE MFG. CO., INC.
 583276 ENGINE WIRE
 HARNESS
 1 REQD./ 950D
 - electrical diagram -

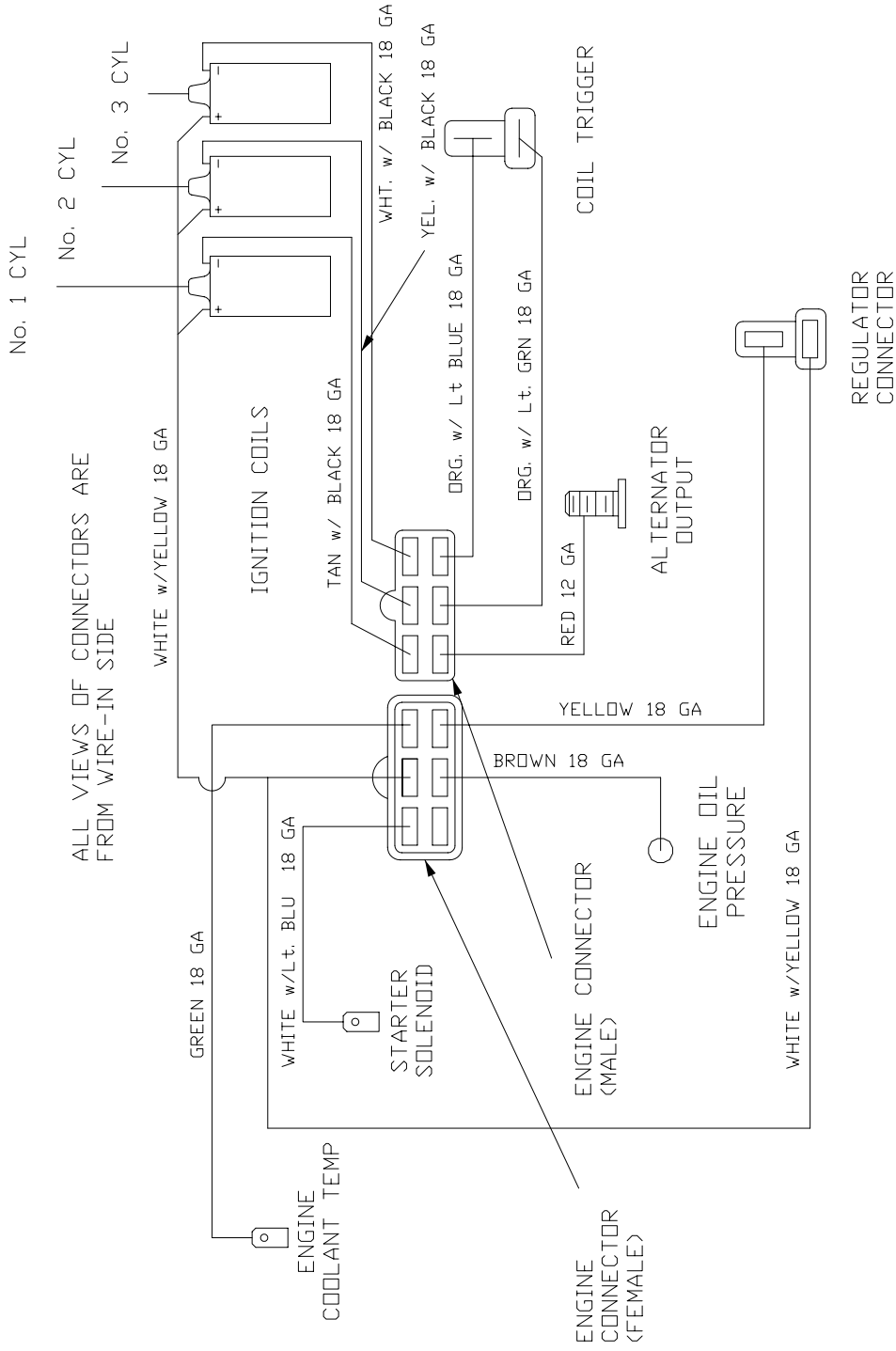

ENCORE MFG. CO., INC.
 583319 ENGINE WIRE HARNESS
 1 REQD./ 950G
 - electrical diagram -

ALL VIEWS OF CONNECTORS
ARE FROM WIRE-IN SIDE

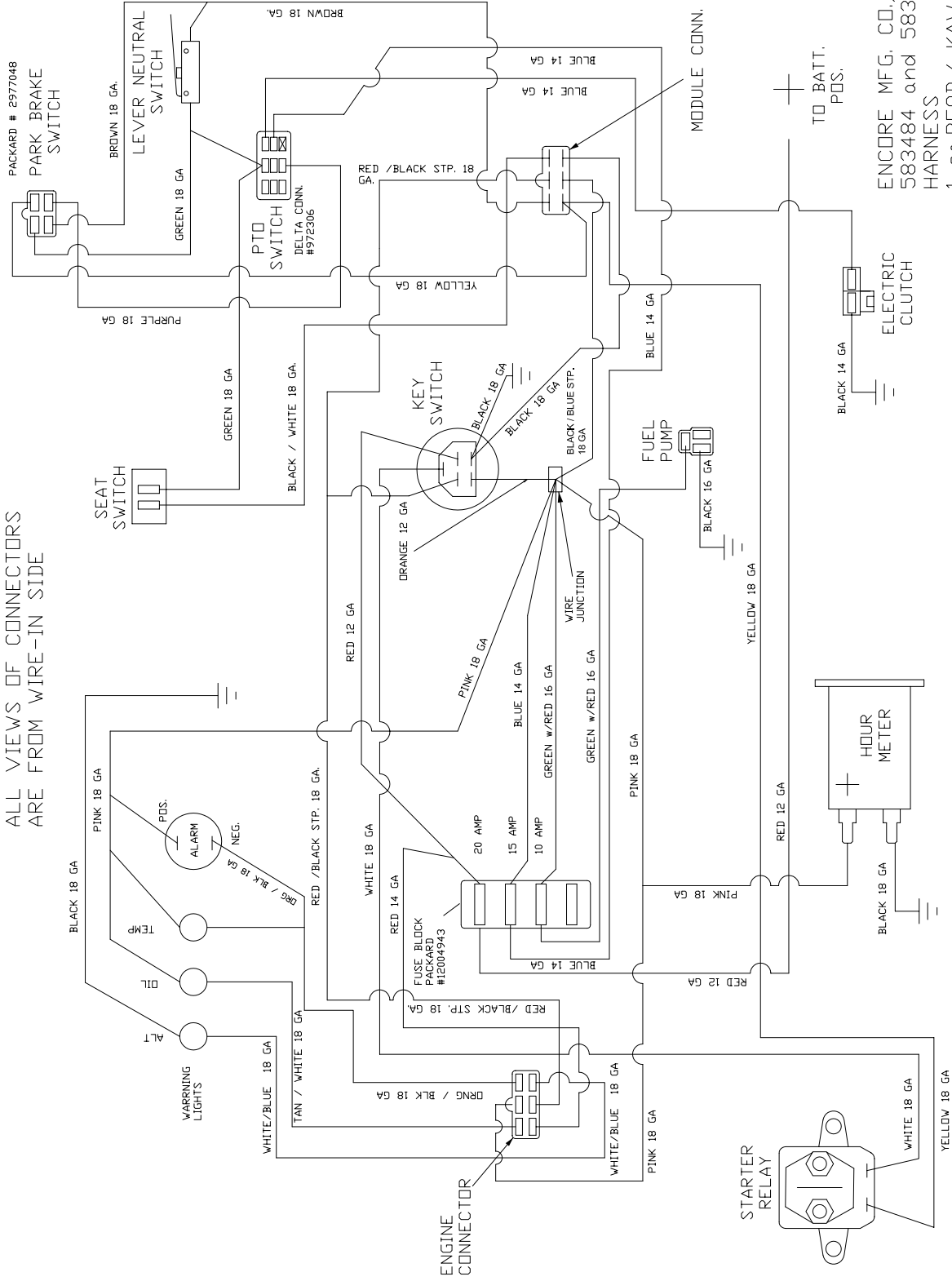

ENCORE MFG. CO., INC.
583484 and 583492 WIRE
HARNES
1 ea.REQD./ KAW 27hp MC & FC
- electrical diagram -

Notes:

Notes:

Notes:

