

X-TREME™

60K25X

OPERATORS MANUAL



Your mower is only as safe as the operator! Operator carelessness or error may result in serious bodily injury. Improper maintenance of the machine may also result in injury. Please read and follow these instructions on Safe Operation and be certain that anyone using this mower fully understands and follows these instructions.

WARNING:

DO NOT allow children to operate the machine. **DO NOT** allow any adult to operate the machine without proper instruction.

1. Familiarize yourself with the controls and know how to stop the rider and mower deck quickly.
2. Inspect your work area carefully. Remove debris from the area to be cut. Keep all bystanders away from the mowing area.
3. Avoid contact with moving parts. Keep hands and feet clear of the mower deck.
4. Never direct the discharge of material toward bystanders nor allow anyone near the machine while in operation.
5. The machine is not intended for highway or street use. Never carry passengers!
6. Never tamper with safety devices or guards. If a guard or safety device is damaged or removed, replace it before operating the rider.
7. Handle gasoline carefully. Use an approved gasoline container. Fill the fuel tank, to within 1" from the neck, with good quality unleaded gasoline.
8. Drive levers must be in the Neutral position and the Blade Clutch must be disengaged before starting engine.
9. Operator must wear proper shoes and clothing, which may include safety glasses and ear protection.
10. Mow only during daylight hours or under very good artificial light.
11. The safety shield over the Grass Discharge area must always be bolted in place and in the DOWN position unless the Grass Catcher is being used.
12. If a solid object has been hit by the blades stop the machine and check for damage. Repair or replace any damaged / broken part prior to restarting the engine.
13. To avoid burns, **DO NOT TOUCH** the engine or muffler immediately after operation.
14. Disengage blades when transporting and when crossing walks and gravel roads.
15. **Do NOT** mow close to drop-offs, deep ditches or other hazards. **Do NOT** stop or start suddenly when going uphill or downhill. Mow up and down the face of steep slopes; **NEVER** mow across the face. If a steep hill must be ascended, **BACK** up the hill, drive forward when descending.
16. Reduce speed and exercise extreme caution on slopes and in sharp turns to prevent tipping or loss of control. Be especially cautious when changing direction on slopes.
17. The Encore X-treme is **NOT** designed for towing. **Only factory approved Grass Collection Systems are permitted.**

CAUTION:

Never add fuel to the tank while the engine is running or hot. **ALWAYS WAIT** at least five minutes before refueling and **REFUEL WITH THE ENGINE OFF. KEEP FUEL AWAY FROM SPARKS OR FLAMES. WIPE AWAY** any fuel spillage **BEFORE** starting unit. Never fill the fuel tank indoors. Wipe up any spilled gasoline. **Gasoline is highly flammable - NO SMOKING.**

Before Operating - Reminders

Fill engine crankcase as per engine manufacturer's manual. **ENGINE DOES NOT HAVE OIL IN CRANKCASE FROM THE FACTORY.** Add proper fuel to fuel tank, open shut-off valve.

The battery is now a gel-cell and will not require acid.

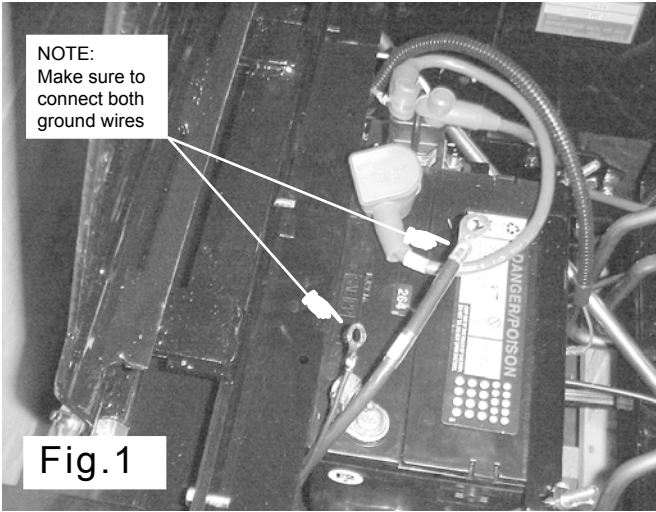

Before hooking up the ground wires make sure that the engine has been filled to the proper level with oil.

If battery will not turn the engine over after hooking the wires up it may require a charge for 15 to 20 minutes.

Raise the unit slightly and place a board under each rear wheel.

With the deck in the raised position start the unit and drive it off the pallet.

Once you are familiar with the contents of this manual you are ready to mow with the finest mower built!

ASSEMBLY INSTRUCTIONS

Remove unit from crate, taking care to remove inner boxes and the small parts box.

1. Remove deflector chute, bolt bag and operator's manual from main assembly.

2. Open bolt bag and lay out bolts:
 - (2) – 5/16 X 1 HHCS
 - (4) – 5/16 X 1 1/4 HHCS
 - (2) – 5/16 Nyloc Nuts
 - (4) – 5/16 Whizlock Nuts
 - (4) – 5/16 Flat Washers
3. Take the 2 - 5/16 X 1 HHCS and 2 – 5/16 Nyloc nuts and bolt deflector into place.
4. Take the 4 – 5/16 Flat Washers and 4 – Nyloc Nuts and fasten seat to the seat plate.
5. Attach the wire harness to the seat switch.
6. Take the remaining bolts and whizlocks nuts and bolt control levers onto the outsides of the handle mounts, adjusting them according to operator comfort. (See Fig. 2)

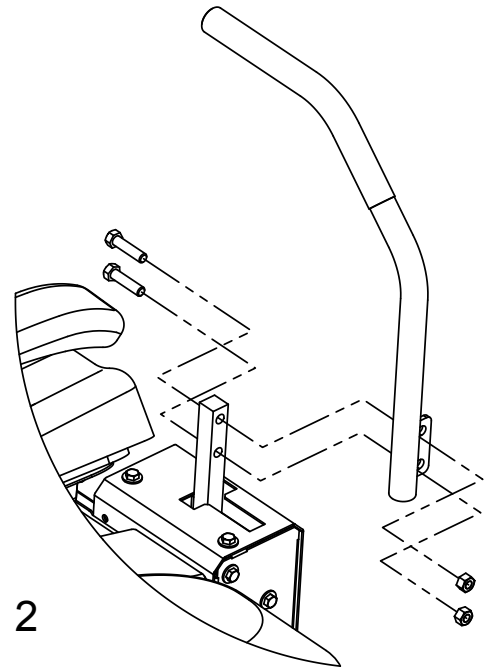

STARTING ENGINE

Throttle control, ignition switch and choke control are located between motion control levers on the front panel under the front of the seat.

Because of a built-in safety interlock system, your machine will not start unless the seat is occupied.

STARTING ENGINE (continued..)

TO START ENGINE: occupy seat, set park brake, leave the motion control levers swung out, move throttle control lever halfway to operating position. Turn ignition key to start position to engage starter, release the key when engine starts. Ignition switch is spring loaded and will return to run position automatically.

Slowly return choke to run position once the engine has started.

STOPPING ENGINE

TO STOP ENGINE: move throttle lever to idle position and turn ignition key to "OFF" position. If engine has been working hard or is hot, allow engine to idle for a short period of time before turning off key. This practice will help cool engine before stopping.

IN CASE OF EMERGENCY engine may be stopped by turning ignition key to "OFF" position.

CAUTION:

Always remove the key and set the parking brake when leaving the machine unattended, even for just a few minutes.

PREVENT ACCIDENTS: Do not give children or unauthorized persons an opportunity to operate this machine.

SAFETY INTERLOCK SYSTEM

Your Encore Rider is equipped with a Safety Interlock System that is designed to help prevent possible serious injuries. Understanding and maintaining this system is vital, for maximum safe operation.

TO START ENGINE:

1. Blades (PTO) must be "OFF".
2. Control levers in neutral (swung out).
3. Park Brake "ON".
4. Operator in seat.

THE ENGINE WILL KILL IF:

1. The operator leaves the seat with:
 - a. The control levers out of neutral (swung in).
 - b. The blades on (PTO).
 - c. The park brake is "OFF".
 - d. All the above.
2. The park brake is set before the control levers are in neutral (swung out)

CORRECT TRANSMISSION OPERATION TO GO FORWARD OR REVERSE

The Encore Rider is equipped with a separate pump and wheel motor for each wheel and are controlled with "Motion Control Levers", one for each wheel.

- To go FORWARD, push both levers forward evenly.
- To go in REVERSE, pull back on both levers evenly.
- To CHANGE DIRECTION, slowly move levers to neutral and move the lever forward in the direction you want to go.
- The further the levers are moved away from the neutral position, the faster the machine will travel. To turn the Rider left or right, slow the speed of the wheel in the direction you want to turn.
- To STOP the Rider, return both levers evenly to the neutral position.

WARNING:

THE ENGINE EXHAUST FROM THIS PRODUCT CONTAINS CHEMICALS KNOWN IN THE STATE OF CALIFORNIA TO CAUSE CANCER, BIRTH DEFECTS OR OTHER REPRODUCTIVE HARMS.

MOWING SPEED

The Encore Rider is designed to operate most efficiently at maximum blade speeds.

MOWING SPEED (continued...)

The running speed of the machine should allow the mower blades to maintain this maximum speed while mowing across turf. Use a slower ground speed for cutting tall grass, grass which is heavy with moisture, or when mowing uphill. If ground speed is too fast, or blade speed is too slow, mowing will be uneven because mower blades will not be able to lift grass into cutting position as the mower passes.

Throttle control regulates speed of engine as measured in RPM. This control SHOULD NOT be used to control ground speed.

MAINTENANCE AND SERVICE

1. Do not adjust mower or change attachments unless the engine has been stopped and the key has been removed.
2. Good maintenance, wiping up gasoline and oil spills, will reduce potential fire hazards.
3. To insure that the mower will remain in safe operating condition, check and tighten all bolts, nuts and screws. Especially make certain the blade bolt/nuts are always tightened properly.
4. Never adjust governor on engine to a faster speed. The engine manufacturer adjusts the engine RPM to the proper setting.
5. Allow time for the engine to cool down prior to storing mower. Do not store mower or gasoline near any open flame or where gasoline fumes may be ignited.
6. Always replace worn or broken parts with genuine Encore repair parts purchased from an authorized Encore dealer. Using anything other than Encore repair parts may void all Encore factory warranties.

OIL AND FILTER for

Change the hydraulic system filter at 250 hours. The hydraulic filter is located on the hydraulic tank. Note: Clean filter area before remounting to prevent contamination. Change hydraulic oil in the reservoir yearly.

Use only a high quality Mobile 1 - 15w50 rated oil. **NOTE: Refer to the engine manual for engine lubrication recommendations.**



CAUTION:
DO NOT SPILL OIL OR GREASE ON BELTS.

TIRE PRESSURE

This vehicle has been designed to achieve maximum operator comfort and ride. This cannot be achieved without proper tire pressure. A low pressure gauge is required to check the front tires.

Front Tires - 14 PSI

Rear Tires - 20 PSI

NOTES:

The Encore Rider is driven and steered by the rear wheels.

REAR TIRE CIRCUMFERENCE DIRECTLY EFFECTS THE TRACKING OF THE MACHINE.

If the machine will not drive in a straight line, check air pressure and adjust accordingly.

BATTERY

The gel-cell battery is maintenance free.

For longest service life, battery should be kept clean by wiping it off with a paper towel. Any corrosion around battery should be removed by applying a solution of one part baking soda to four parts water. A light coating of grease or petroleum jelly may be applied to all exposed terminal surfaces to prevent corrosion.

CAUTION:

When servicing the battery or any other part of the electrical system, or if the battery must be removed for any reason, always, disconnect negative (ground) cable FIRST and reconnect it LAST to avoid possibility of electrical shorts.

At temperatures below 32° F (0° C), full charge state must be maintained to prevent cell electrolyte from freezing and causing permanent battery damage.

CAUTION:

Batteries produce flammable hydrogen gas. Avoid creating sparks and open flames and do not smoke when working near batteries.

Battery electrolyte solution is poisonous and can be injurious to eyes, skin and clothing.

IN THE EVENT OF AN ACCIDENT: Flush affected area immediately with a solution of one part baking soda to four parts water. If baking soda is not readily available, flush affected area with water. Notify physician immediately.

LUBRICATION

There are 5 grease points on the X52. One on each caster, one on the caster swivel and one on the foot pedal pivot. These are all pre-greased from the factory. Environmental conditions may be cause to vary frequency.

Before each use:

- Clean engine chaff screen
- Check engine oil and tire pressure

Every 40 hours:

- Lubricate Casters (3 Pumps)
- Lubricate Deck Height Foot-Pivot (1 Pump)

Every 100 hours:

- Lubricate Caster Swivels (3 Pumps)
- Lubricate drive and pump control pivot points
- Check belt tension

BELT ADJUSTMENT

Remove key from the ignition switch. The deck drive belt, which may be accessed by removing the deck plate, (see fig.3) has

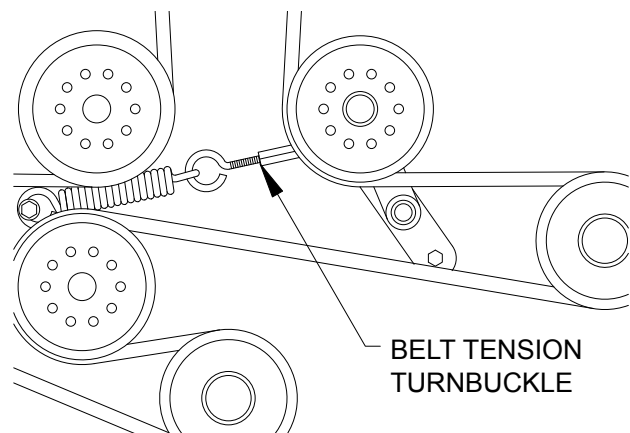

Fig. 3 - Turnbuckle Location

a turnbuckle assembly to adjust spring tension. Spring tension should be maintained at 4" of spring stretch measuring the spring coils. By turning the turnbuckle clockwise it will increase tension, counter-clockwise will decrease tension.

BELT ADJUSTMENT (continued...)

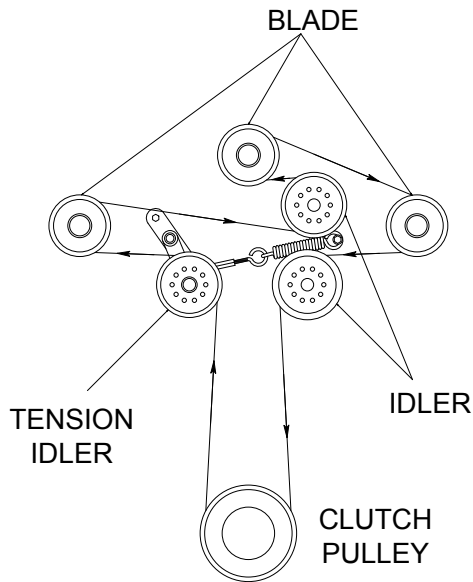

Fig. 4 - Mower Deck Belt Layout
When installing a belt refer to fig. 4 as to the route of the belt.

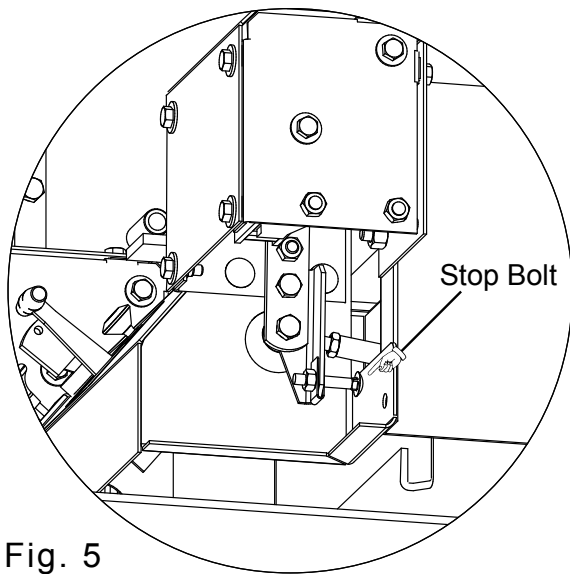

Fig. 5

TRACKING

To adjust the tracking there is a stop bolt located on the bottom side of the steering control. (See Fig. 5)

To adjust tracking simply loosen the lock nut on the stop bolt and turn bolt clockwise to increase speed or counter clockwise to decrease speed.

DRIVE ADJUSTMENTS

Steering and motion controls should be uniform in all forward and reverse speeds. Levers should automatically return to neutral when released.



CAUTION:
TURN OFF ENGINE BEFORE MAKING ANY ADJUSTMENTS.

To test drive operations:

- Check air pressure in tires. Equal tire pressure is critical for proper drive operation.
- Check linkage for excessive play.
 - Raise rear of Rider until rear wheels are off the ground. Safely block the frame in this position.
 - Put control levers in neutral lock position (control levers swung outward).
 - Start engine.

DECK HEIGHT ADJUSTMENT

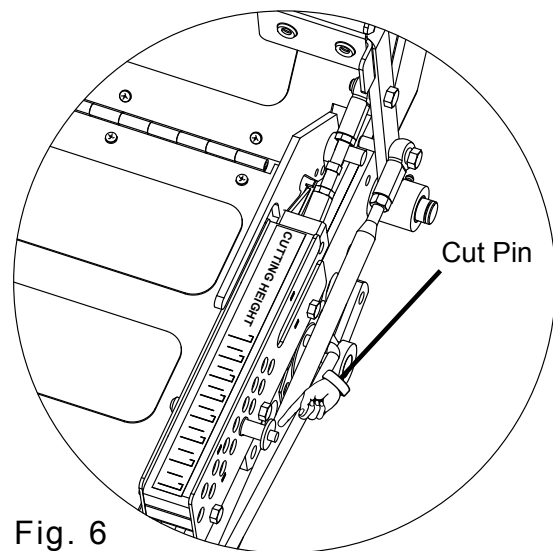

Fig. 6

Mower heights can be adjusted by pushing the foot pedal and by depressing the height of cut pin and removing it. Select cutting height and set pin accordingly.

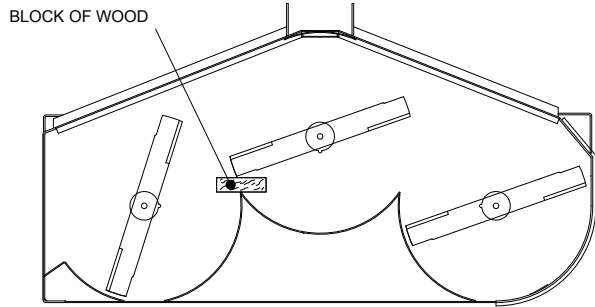

Fig. 7

BLADES

When removing blades, block front end up or run front wheels onto ramps. Stop engine, **remove key from the ignition switch**, and apply park brake. To remove, simply hold blade bolt on bottom of the cutter housing (See Fig. 7) and turn nut counter-clockwise. Reverse procedure to reinstall. Blade bolts should be torqued to 90 ft.lbs.

Note: Deck spring washer should always be cup side up or cup side to blade to insure proper torque on the blades.

⚠ CAUTION:

Mower blades are sharp and can cut you during blade maintenance or adjustment. Use suitable covering over cutting edges of blades to prevent bodily harm.

To obtain optimum mowing results, mower blades should be kept sharp and well balanced. File or grind blades evenly. Take care to retain angle of original cutting edge.

CHARGING SYSTEM

An alternator is used to charge the battery. The alternator charging system normally requires no service other than periodically checking that all exposed wiring and electrical connections on the machine are clean, tight and in good condition.

⚠ WARNING:

NEVER RUN THE ENGINE IF THE BATTERY IS REMOVED OR IF THE BATTERY IS NOT CONNECTED TO THE CHARGING SYSTEM. SERIOUS DAMAGE TO CHARGING SYSTEM COMPONENTS MAY RESULT.

Proper polarity is critical with an alternator equipped charging systems. Always disconnect battery cable (negative) before working on any part of the electrical system. Verify all components are connected correctly before reconnecting ground cable (negative) or damage to alternator system components will result.

DECK LEVELING ADJUSTMENT

Before checking the deck level makes sure that tire pressures are inflated to the proper level. Begin by setting the deck to a fixed position and pointing the blades to the front edge of the deck.

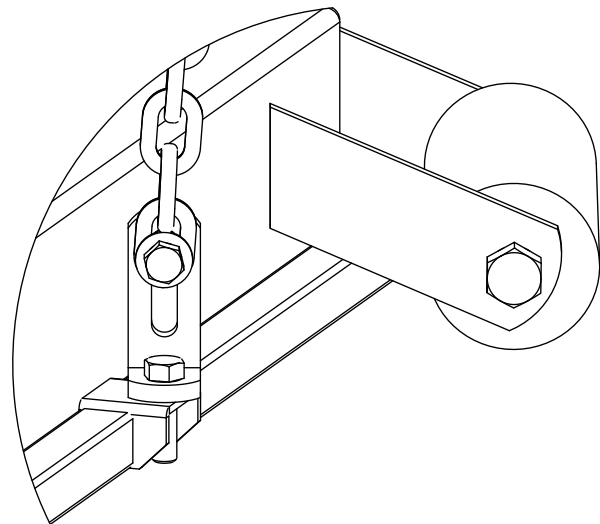

Fig. 8

Measuring from the blade to the ground on each side of the deck will give the best reading. To adjust deck position loosen the

DECK LEVELING ADJUSTMENT (continued...) **Notes:**

bolt on the deck hanger bracket and move bolt in the slot either up or down depending which way you need to move the deck. You should always maintain at least a 1/8 inch of deck pitch from front to back. Also all four chains must support the deck equally or must have equal tension on them.

ELECTRICAL

The fuse box is located under the seat on a panel mounted to the seat frame. There are two (2) fuses that run the system, the top fuse, which is a 20 amp, is the main fuse. The second, a 15 amp fuse, takes care of the electric clutch. The third and fourth slots are blank extras. If there is a recurring fuse failure, check the electrical system for a short.

ELECTRICAL DIAGRAMS

X-Treme rider electrical diagram is on page 10.

Notes:

52K23X

423351 WIRE HARNESS
ELECTRICAL DRAWING

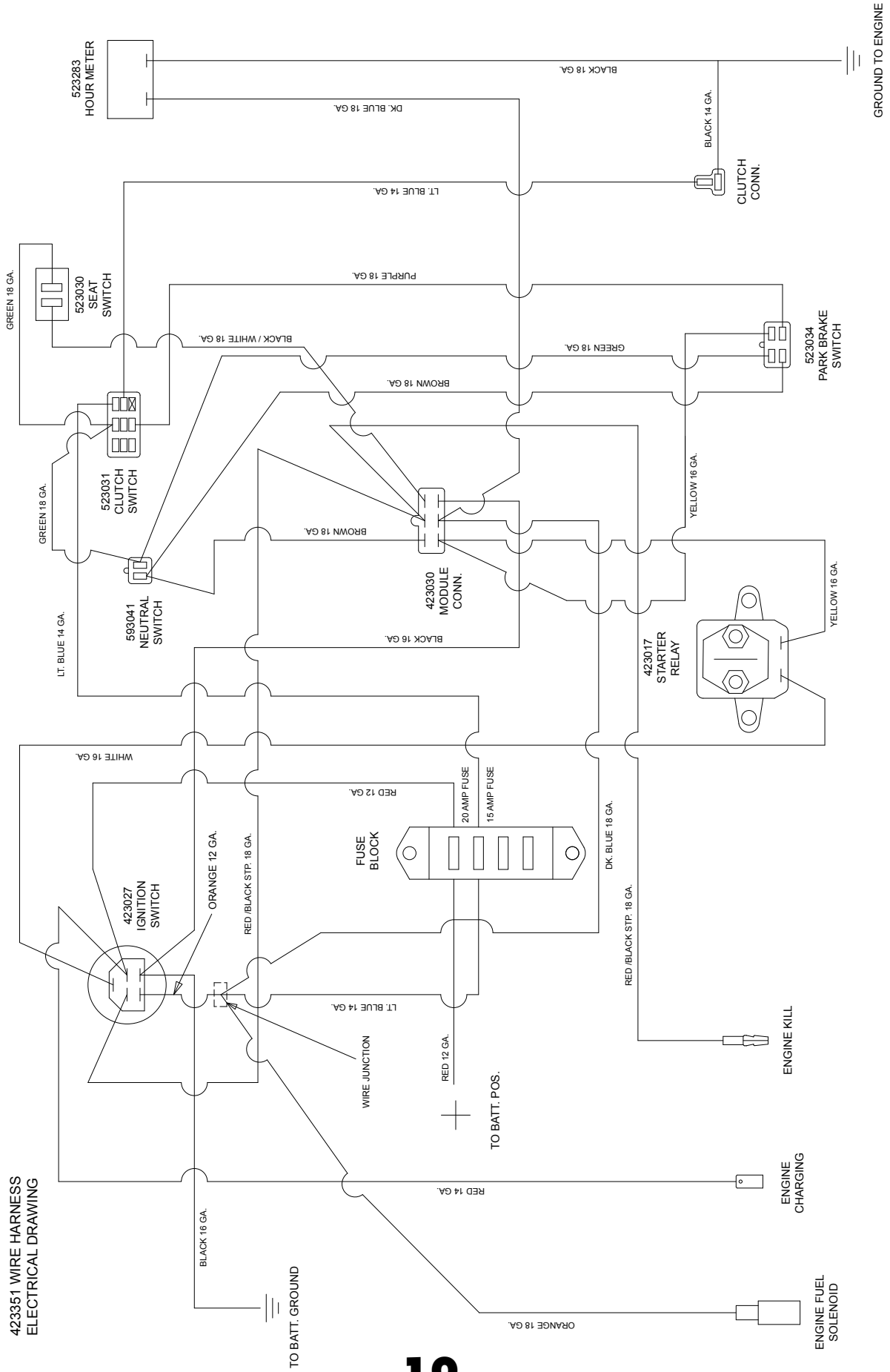

ENCORE WARRANTY

For Encore Riding Mowers

This warranty extends to the original retail purchaser only and commences on the date of original retail purchase. Any part of the Encore commercial mower manufactured by Encore Mfg. Co., Inc. and found in reasonable judgment of Encore Mfg. Co., Inc. to be defective in material or workmanship will be repaired or replaced by an Authorized Encore Dealer without charge for parts and labor. The Encore mower including any defective part must be returned to an Authorized Encore Service Dealer within the warranty period. The expense of delivering the mower to the dealer for warranty work and the expense of returning it back to the owner after repair or replacement will be paid by the owner. This warranty is limited to two years for frame, hydrostatic drive system (excluding hoses), cutter housings, gearbox, and driveshaft. The warranty will be **2 years from the date of purchase** against defects in workmanship and materials (90 days for rental use) for any Encore rider that is used for homeowner, commercial or any other income producing purpose. Belts, batteries, and tires are warranted for 90 days against defects in materials and workmanship. The deck warranty will be **10 years from the date of purchase** against defects in workmanship and materials (90 days for rental use) for any Encore rider that is used for homeowner, commercial or any other income producing purpose. Cutter housings, electrical components, hydraulic components and electric-clutch must be returned before warranty will be paid.

The engine is covered by its respective manufacturer please refer to the manufacture's warranty statement that is included in the literature packet. Engine warranties should be referred to the nearest authorized service outlet of the engine manufacturer.

The responsibility of Encore Mfg. Co., Inc. in respect to claim is limited to making the required repairs or replacements, and no claim of breach of warranty shall be cause for cancellation or recession of the contract of sale of any Encore mower.

Proof of purchase is required by both Encore and the servicing Dealer, before any warranty will be paid, and warranty work must be preformed by an Authorized Encore service dealer.

This warranty does not cover any Encore mower that has been altered or modified so as to adversely affect the intended use of the product, it operation, performance, or durability. This warranty also does not cover any mower that has been subject to misuse, neglect, negligence, accident or that has been operated in any way contrary to the operating instructions as specified in the Operators Manual.

Encore Mfg. Co., Inc. reserves the right to change or improve the design of any mower without assuming any obligation to modify any mower previously manufactured.

Encore Mfg. Co., Inc. obligation under warranty is strictly and excessively limited to repair or replacement of defective parts. Encore Mfg. Co., Inc. does not assume or authorize anyone to assume for them any other obligation.

ENCORE MFG. CO., INC. CANNOT BE RESPONSIBLE FOR THE WAY YOU OPERATE, OR THE CONDITIONS IN WHICH YOU OPERATE THE MOWER. USE COMMON SENSE AT ALL TIMES.

As of September 1, 2004 this warranty statement supersedes any warranty statement published by ENCORE MANUFACTURING CO., INC.

