



60B350E

**OPERATORS
MANUAL**



Your mower is only as safe as the operator! Operator carelessness or error may result in serious bodily injury. Improper maintenance of the machine may also result in injury. Please read and follow these instructions on Safe Operation and be certain that anyone using this mower fully understands and follows these instructions.

1. Familiarize yourself with the controls and know how to stop this mower.



WARNING:

DO NOT allow children to operate the machine. **DO NOT** allow any adult to operate the machine without proper instruction.

2. Inspect your work area carefully. Remove debris from the area to be cut. Keep all bystanders away from the mowing area.
3. Avoid contact with moving parts. Keep hands and feet clear of the mower deck and all moving parts.
4. Never direct the discharge of material toward bystanders nor allow anyone near the machine while in operation.
5. Never tamper with safety devices or guards. If a guard or safety device is damaged or removed, replace it before operating the mower.
6. Handle gasoline carefully: use an approved gasoline container; fill the fuel tank to within 1" from the neck with good quality leaded or unleaded gasoline. Operator must wear proper shoes and clothing, which may also include safety glasses and ear protection.

7. Mow only during daylight hours or under very good artificial light.
8. Do NOT mow in slippery conditions, keep a firm grip on the handle bars, NEVER RUN.
9. The safety shield over the grass discharge must always be bolted in place and in the down position unless the grass catcher back plate is completely installed.
10. Do NOT leave the operator position unless the engine has been killed and blades have stopped.
11. If a solid object has been hit by the blades, stop the machine and check for damage. Repair or replace damaged/broken part(s) prior to restarting the engine.
12. Do NOT allow anyone to stand or walk on the grass discharge side of the mower when the mower is in operation.
13. Do NOT mow close to drop-offs, deep ditches or other hazards. Mow hillsides very carefully by mowing across the face of slopes, not up or down. Do NOT mow on steep slopes.
14. To avoid burns, DO NOT TOUCH the engine or muffler immediately after operation.



CAUTION:

Never add fuel to the tank while the engine is running or hot. ALWAYS WAIT at least five minutes before refueling and REFUEL WITH THE ENGINE OFF. KEEP FUEL AWAY FROM SPARKS OR FLAMES. WIPE AWAY any fuel spillage BEFORE starting unit. Never fill the fuel tank indoors. Wipe up any spilled gasoline.
Gasoline is highly flammable - NO SMOKING.

SPECIFICATIONS

Belt Tension Guide

Belt	Inch Deflection	How to Adjust
Engine to Deck	1/2"	Turnbuckle at Idler
Right Blade Drive	1/2" (48", 52", And 60" only)	Threaded Rod
Engine to Pump	1/2"	Fixed idler with Slot

Hydraulic System

Capacity	9.5 quarts (9.01) w/filter change (2 inches below the top of the fill neck)
Filter	Encore P/N 453048 (Units Prior SN 31078) Encore P/N 423063 (Units After SN 31078)
Oil	A High quality 20W50 API CD Rated

NOTE: 20W20 oil is acceptable in cooler conditions

Assembly Instructions

1. Remove inner parts box and handle from crate. Remove outside frame work so that the mower is setting on the pallet.
2. On a 36" mower, use 3 – 5/16" X 1 3/4" bolts and 3 – 5/16" whizlocks and bolt the bumper into place. (On the 48" there are 4 - bumper bolts required.) The whizlocks should go to the inside of the deck. When assembling a 48" mower, make sure that the bumper is flush with the deck on both ends of the bumper.
3. Using 6 – 3/8" X 1" bolts (3 – used for each caster) and 6 – 3/8" whizlock nuts, bolt the casters into place. Position whizlock nuts to the inside of the deck.
4. Using 2 – 1/4" X 3/4" bolts and 2 – 1/4" nyloc nuts secure the speed control lever assembly to the **underside** of the mount plate on the lower handle. Connect the speed control link to the control cam arm and secure with 1 - 1/4" nyloc nut.
5. Mount the gas tank using the 2 – nylon hold down straps, pulling tension on the buckles until secure. Attach the quick coupler on the end of the fuel line to the bottom of the tank.

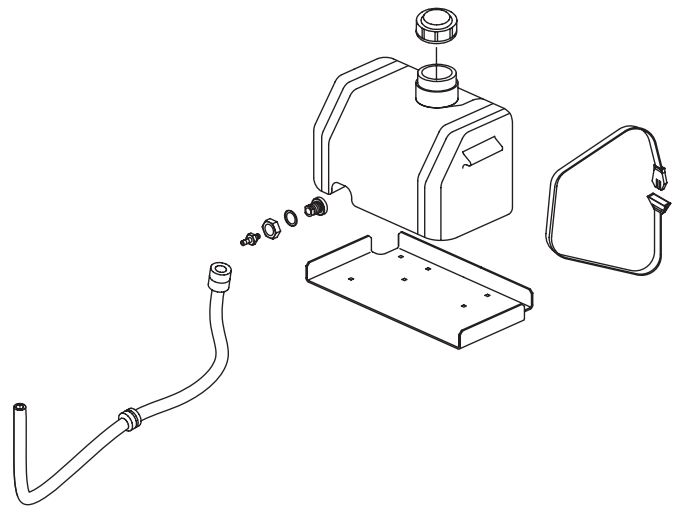

Fig. 1

6. Using the remaining 3/8" X 1" bolts and the 4 – 3/8" nyloc nuts, bolt the upper handle into position. (Remember that there are 3 – height settings for the

Assembly Instructions

handle for operator comfort.) Route the wiring harness along the handle, plugging it into the blade control switch, o.p.c. and speed control switch located under the speed control plate. There is not a specific color code for hooking up the harness. Run the throttle cable around the left hand side of the engine to the throttle plate, attaching the cable to the top side of the plate on Vanguard engines. Loosen screw on throttle control handle and adjust cable so throttle operates properly.

7. At this point, you are ready to oil and fuel the engine. With that being done, take the unit and raise the rear wheels off the ground so that they may free wheel. Block the unit up securely so that you may run the engine with no danger of it falling from the stand. With the speed control in the neutral position, start the engine and run it at 3/4 to full throttle. Using a 5/16" wrench adjust the speed control link, to set the right hand wheel to neutral no matter what the left hand wheel does. With that accomplished, lock the lock nuts into place on speed control link. If the left hand wheel is not neutralized use a 1/2" wrench, to break the lock nut loose on the pump link and adjust the rod end to neutral the left hand wheel. After accomplishing neutral, shut the engine off and remove the support blocks from under the machine. With the engine shut down, take the drive rods and bolt them onto the main control shaft using the 5/16" nyloc nuts provided. Adjust the length of the rod so that the pins in the drive levers are just a little under center of the neutral lock on the thumb lock. (See fig.)
8. You are ready for your test run to set the full speed tracking. Remember to check the air pressure in the tires. Rear wheels

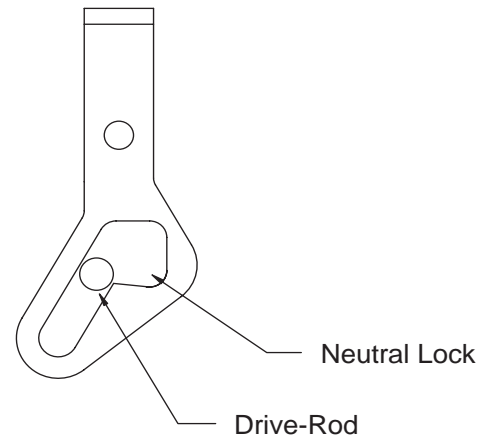

Hydro Drive Thumblock

Fig. 2

should be set at 12 psi, front casters to 20 psi. Run unit at full throttle and set control lever to the full speed setting. The test run should be made on some type of hard surface with the ground being fairly level. If the machine pulls one way in full speed, adjust the slow side stop bolt up to speed up the slow motor. If there is not enough adjustment to speed up the slow motor, you may have to lengthen the stop bolt on the fast side. Run that machine at an intermediate speed. If you have a tracking problem after full speed tracking is set, the adjustment is in the pump arm rod end. This is remedied by adjusting the length of the pump arm. Brake the lock nut loose on the pump arm and remove the bolt from the rod end that attaches it to the link. To increase the pump speed, shorten the pump arm. To decrease the speed, lengthen the pump arm. Usually about two full turns on the pump arm rod end to speed up or slow down is adequate. (See fig.)

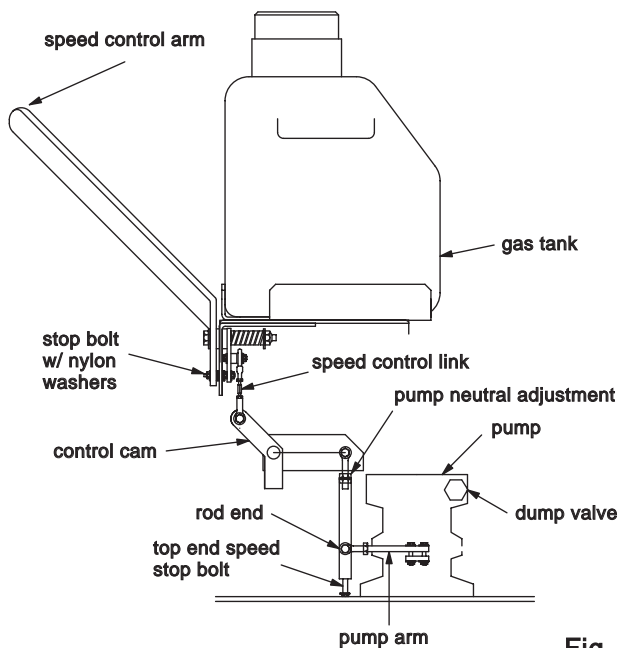

Fig. 3

Final Check / Adjustment

1. Check all oil levels (engine and hydraulic oil tank). See engine manual for proper engine oil level. See specifications for hydraulic oil level.
2. Check air pressure in drive wheels (12 psi) and caster wheels (20psi).
3. Check for proper belt tension (see guide). Keep a 1/8" to 1/4" clearance between belt guides and belts with belt tension applied. Check for leaks at all hose connections.



CAUTION:

Excessive belt tension may cause damage!!.

4. After a 10 hour "Break-In" period go through steps 1 thru 3.
5. Proper adjustments must be maintained to insure safe, trouble free, long life operation of the mower. After completing the foregoing instructions and recommended procedures you are ready to put the mower into operation.

BEFORE OPERATING

- Know your machine top to bottom.
 - Make certain all safety standards and instructions have been fully read and understood.
 - Be acquainted with all "SAFETY INSTRUCTIONS" in this manual – to start.
1. Fill the fuel tank and open the fuel valve.
 2. Speed Control Lever is in "Stop" position (Top of lever all the way to the left).
 3. Blades disengaged (Lever all the way back).
 4. Control cables locked in neutral at the thumb latches.
 5. Choke engine as required and start.
 6. After engine is running, push blade engagement lever forward to engage blades.
 7. Move the Speed Control Lever to desired speed. (Starting out slow and moving up to speed while moving is recommended.)
 8. Grip the Drive Levers just enough to hold them in the neutral or stopped position.
NOTE: Squeezing the Drive Levers past the neutral or stopped position will result in the mower backing up. (This is the "Finger Tip" reverse feature). Push forward on the thumb locks to unlock the Drive Levers. Slowly release the Drive Levers to move forward.
 9. In the all forward mode, the mower will travel straight. Slight turning can be done by simply pushing the mower manually right or left via the handles. More substantial turns are done by squeezing the Drive Levers until the mower turns the desired amount. To make a counter rotating turn (one wheel forward, the other reversed) is accomplished by squeezing one of the Drive Levers to the stop position.

Before Operating

10. To stop forward motion, squeeze both Drive Levers until the mower stops. Lock the levers using the thumb latches. Move the Speed Control Lever to the stop position.

IMPORTANT!: To move the unit with the engine stopped, the dump valve on each pump must be cracked open. This is the 5/8" Hex Nut located on the top, front, right side of each pump. Turn the valve counter clockwise to

open. The hydrostatic pumps will not operate properly with these valves open.

The mower is equipped with "Operator Presence Controls" on the upper handle. When the operator leaves the operator zone, removing (both) hands from the Operator Presence Control Levers will cause the engine to kill. **THIS FEATURE IS FOR YOUR SAFETY!**

WARNING:

FAILURE TO FOLLOW THE PREVIOUS INSTRUCTIONS MAY RESULT IN SEVERE BODILY INJURY OR MECHANICAL FAILURE.

PLEASE BE CAREFUL !

SAFETY DECALS

In order to promote safe operation, Encore Mfg. Co., Inc. supplies safety decals on all products manufactured. Because damage can occur to safety decals through shipment, use or reconditioning, Encore will, upon request, provide safety decals for any of our products in the field at No Charge. Contact your authorized Encore dealer for more information.



363038



363023



363001

ENCORE

HEIGHT ADJUSTMENT

REAR DECK MOUNT IN HIGHEST POSITION

- (5) spacers on top of caster arm = 1 7/8" to 3 1/8"
- (4) spacers on top of caster arm = 2 1/8" to 3 3/8"
- (3) spacers on top of caster arm = 2 1/2" to 3 3/4"
- (2) spacers on top of caster arm = 2 5/8" to 3 7/8"
- (1) spacer on top of caster arm = 2 7/8" to 4 1/8"
- All spacers under caster arm = 3 1/4" to 1 1/2"

REAR DECK MOUNT IN LOWEST POSITION

- (5) spacers on top of caster arm = 1 1/2" to 2 3/4"
- (4) spacers on top of caster arm = 1 3/4" to 3"
- (3) spacers on top of caster arm = 2" to 3 1/4"
- (2) spacers on top of caster arm = 2 3/8" to 3 3/8"
- (1) spacer on top of caster arm = 2 5/8" to 3 7/8"
- All spacers under caster arm = 2 7/8" to 4 1/8"

NOTE: Use 1/4" blade spacers to achieve cutting height between the above measurements.

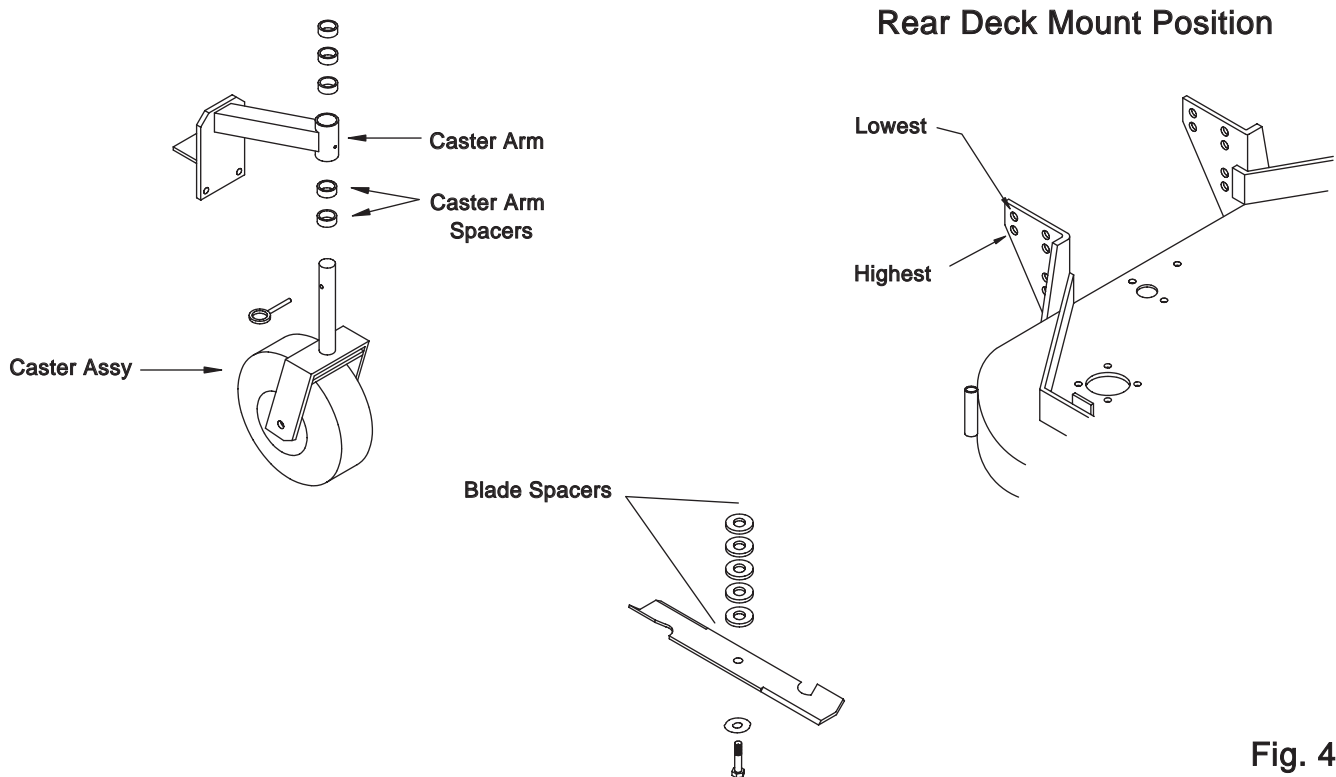

Fig. 4

LUBRICATION / MAINTENANCE

The following recommendations should be used to ensure proper and safe operation of the mower.

LUBRICATION

(Units Prior to Serial Number 33333)

Grease Daily:

- Idler Arm
- Caster Wheels and Caster Pivots
- Drive Wheels

Grease Every 100 Hours:

- Bell Crank Pivot Bearing

Grease Every 250 Hours:

- Cutter Housing Bearings

⚠ CAUTION:

When greasing Cutter Housing, grease each one with *TWO PUMPS ONLY*.

Excessive greasing can force seals out causing premature bearing failure.

LUBRICATION / MAINTENANCE

LUBRICATION

(Units After Serial Number 33333)

Grease Daily:

- Idler Arm
- Caster Wheels and Caster Pivots
- Drive Wheels

Grease Every 100 Hours:

- Bell Crank Pivot Bearing

Replace Hydraulic Filter and oil after 150 hours “break-in” and 500 hours or once a year then on using 9.5 quarts of 20W 50 oil.



CAUTION:

Do not spill Oil or Grease on Belts.

MAINTENANCE

1. Engine: For complete maintenance and operating information for your engine, please refer to your engine operating and maintenance manual provided by the engine manufacturer.
2. Belts: The drive and deck belts should be checked and adjusted after the first 10 hours of use and then every 50 hours from that point on.
3. Tires: Correct tire pressure is essential for efficient operation of the mower.
4. Check tire air pressure periodically. Inflate tires to the pressures listed:
 - Drive Wheels = 12 psi
 - Caster Wheels = 20 psi



CAUTION:

DO NOT ADJUST OR CHANGE ATTACHMENTS UNLESS SPARK PLUG WIRE HAS BEEN DISCONNECTED AND THE ENGINE HAS STOPPED.



5. Mower Blades: Check sharpness of mower blades after every 10 hours of operation.

To sharpen blades proceed as follows:

- Block the front end of the mower up or run front end up on ramps
- Remove blade by turning bolt counter clockwise.
- Sharpen blade with a hand file, electric grinder or blade sharpener. Wear gloves and eye protection when sharpening. Grind blade at original bevel.
- Check balance of blade by positioning the blade on a nail or blade balance pedestal. Grind the blade on the end that is heavier until both sides balance.
- Reinstall blades.

6. BATTERY:

See battery manufacturer's instructions for proper maintenance of battery.



WARNING:

AVOID SERIOUS INJURY OR DEATH:

- THE BATTERY CONTAINS SULFURIC ACID. AVOID CONTACT WITH SKIN, EYES OR CLOTHING. **ANTIDOTE: INTERNAL** – DRINK LARGE QUANTITIES OF WATER OR MILK. FOLLOW WITH MILK OF MAGNESIA, BEATEN EGG OR VEGETABLE OIL. CALL A PHYSICIAN IMMEDIATELY. **EYES AND SKIN** – FLUSH WITH WATER AND GET PROMPT MEDICAL ATTENTION.
- BATTERIES PRODUCE EXPLOSIVE GASES, KEEP SPARKS, FLAMES AND SMOKING MATERIALS AWAY. VENTILATE WHEN CHARGING IN AN ENCLOSED SPACE. WEAR EYE PROTECTION WHEN WORKING NEAR BATTERIES.
- KEEP OUT OF REACH OF CHILDREN.

ENCORE

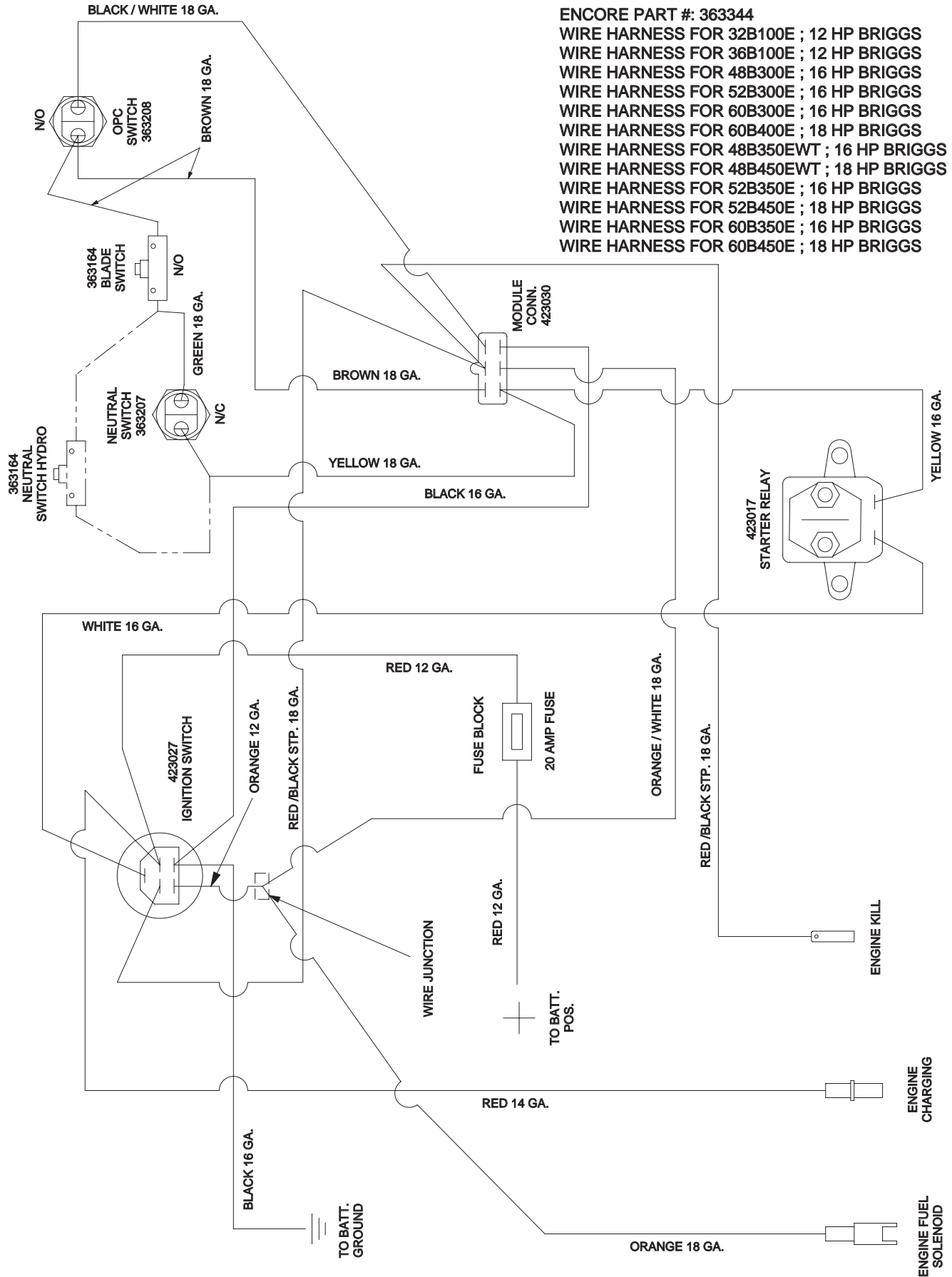

ENCORE PART #: 363373
 WIRE HARNESS FOR 48K450EWT ; 17 HP KAWASAKI
 WIRE HARNESS FOR 48K550EWT ; 19 OR 20 HP KAWASAKI
 WIRE HARNESS FOR 52K450E ; 17 HP KAWASAKI
 WIRE HARNESS FOR 52K550E ; 19 OR 20 HP KAWASAKI
 WIRE HARNESS FOR 60K550E ; 19 OR 20 HP KAWASAKI

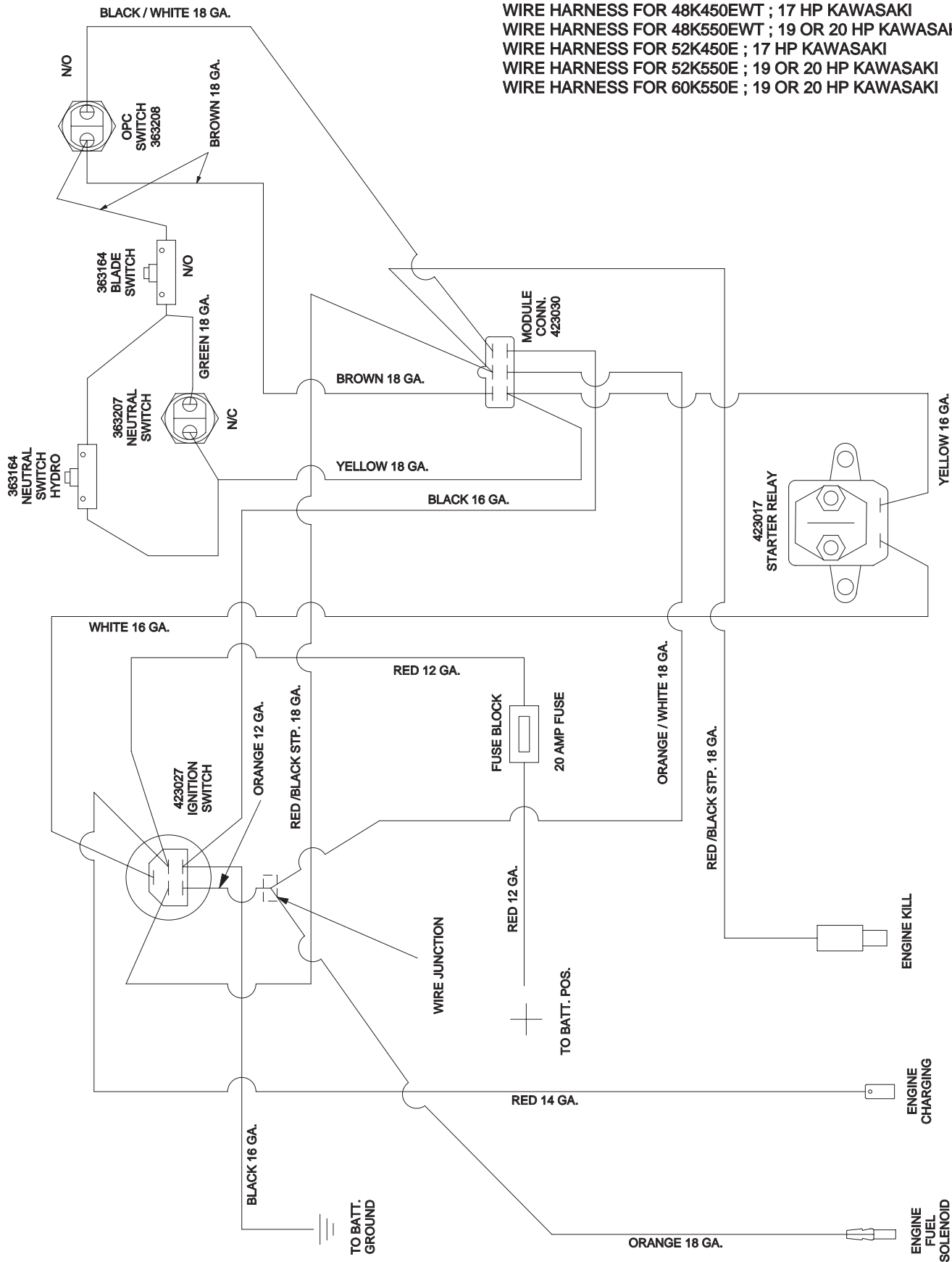

ENCORE

NOTE CHANGES AT CONN .red wire was at B slot
black wire was at E slot
1-21-99 dlm

NOTE CHANGES AT CONN .red wire was at A slot
yellow wire was at D slot
brown wire was at B slot
black wire was at F slot
green wire was at E slot
12-9-98 dlm

ENCORE PART #: 453029
WIRE HARNESS FOR 48B350WT ; 16 HP BRIGSS
WIRE HARNESS FOR 48B450WT ; 18 HP BRIGSS
WIRE HARNESS FOR 52B350 ; 16 HP BRIGSS
WIRE HARNESS FOR 52B450 ; 18 HP BRIGSS
WIRE HARNESS FOR 60B350 ; 16 HP BRIGSS
WIRE HARNESS FOR 60B450 ; 18 HP BRIGSS

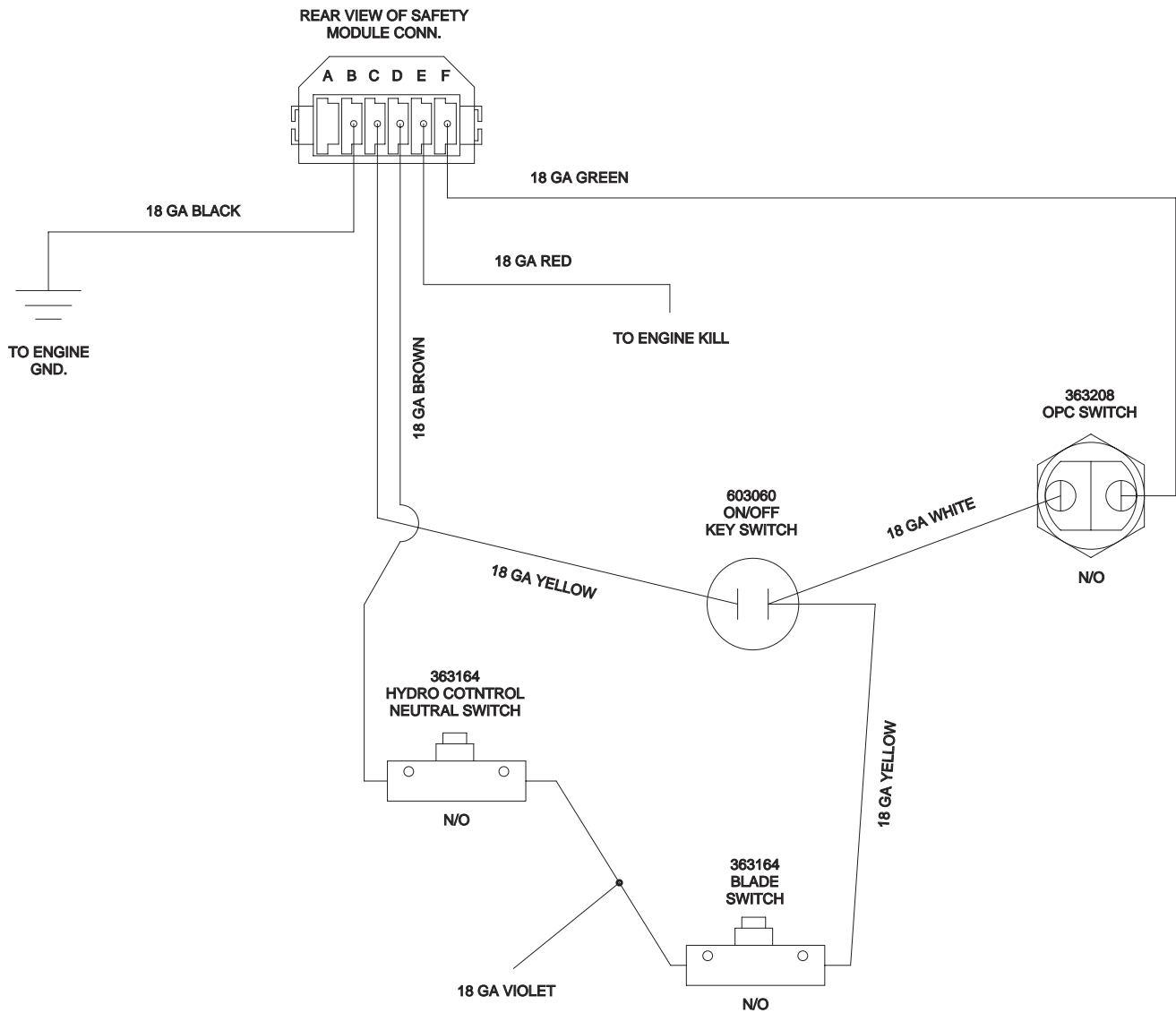

NOTE CHANGES AT CONN .red wire was at B slot
black wire was at E slot
1-21-99 dim

NOTE CHANGES AT CONN .red wire was at A slot
yellow wire was at D slot
brown wire was at B slot
black wire was at F slot
green wire was at E slot
12-9-98 dim

ENCORE PART #: 453160

WIRE HARNESS FOR 36K450 ; 17 HP KAWASAKI

WIRE HARNESS FOR 48K450WT ; 17 HP KAWASAKI

WIRE HARNESS FOR 52K450 ; 17 HP KAWASAKI

WIRE HARNESS FOR 60K450 ; 17 HP KAWASAKI

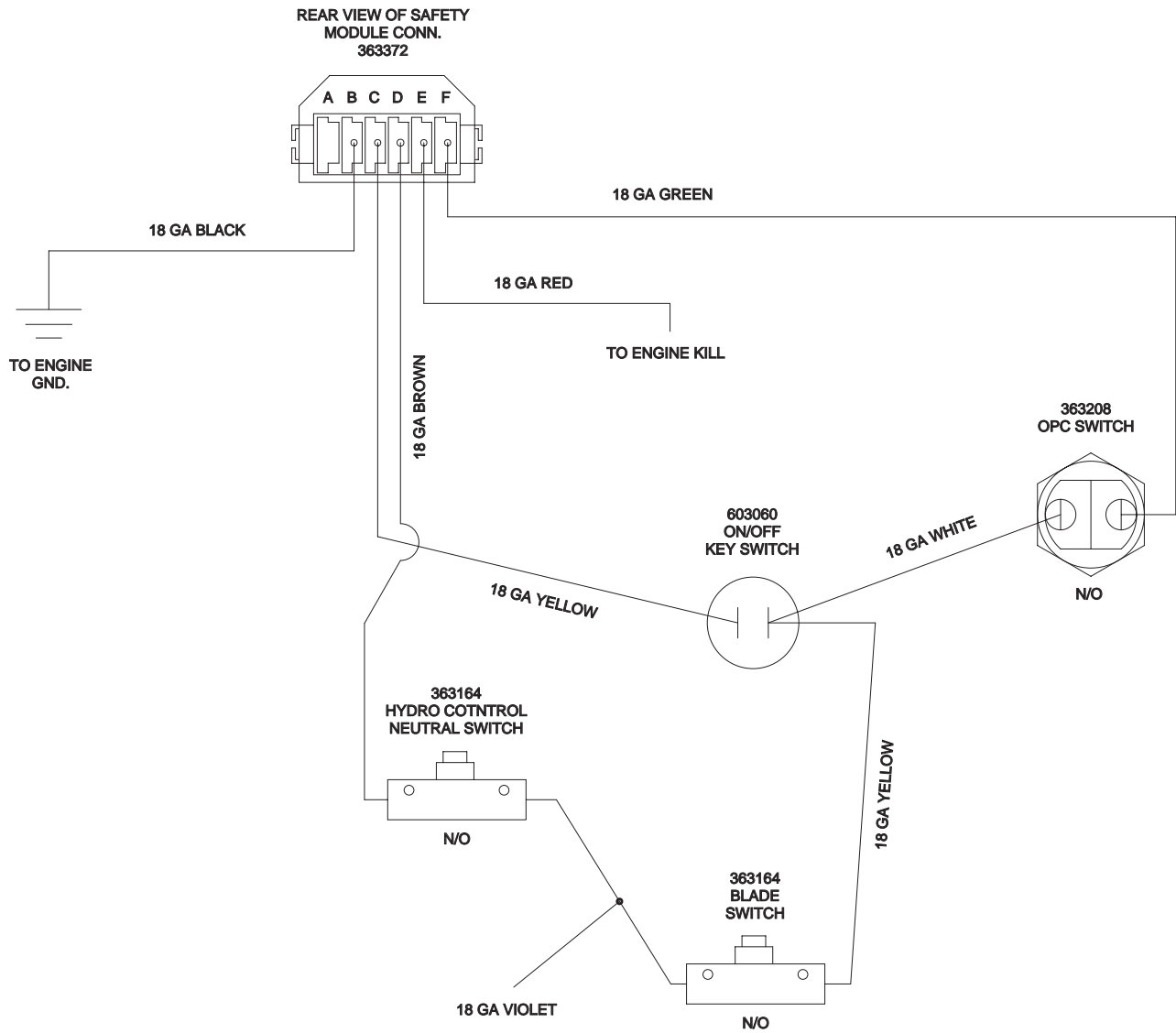

ENCORE PART #: 453164
WIRE HARNESS FOR 32K250 ; 14 HP KAWASAKI
WIRE HARNESS FOR 36K250 ; 14 HP KAWASAKI

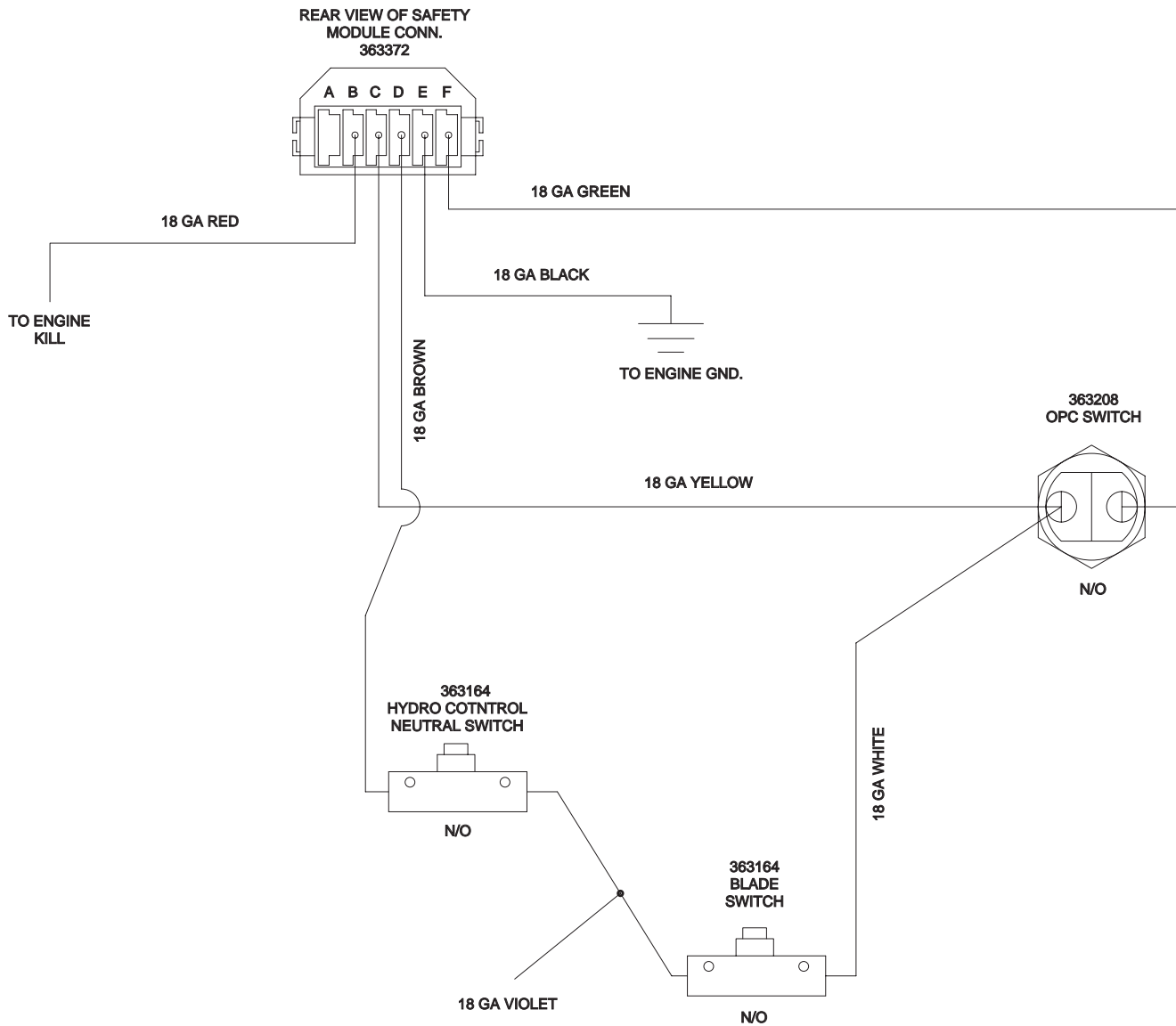

Notes:

ENCORE WARRANTY

This warranty extends to the original retail purchaser only and commences on the date of original retail purchase. Any part of the Encore commercial mower manufactured by Encore Mfg. Co., Inc. and found in reasonable judgement of Encore Mfg. Co., Inc. to be defective in material or workmanship will be repaired or replaced by an authorized Encore Mfg. Co., Inc. dealer without charge for parts and labor. The Encore mower, including any defective part, must be returned to an authorized Encore service dealer within the warranty period. The expense of delivering the mower to the dealer for warranty work and the expense of returning it back to the owner after repair or replacement will be paid by the owner. Should any part prove to be defective within the two years of original purchase (90 days for rental purposes), this part will be replaced F.O.B. Beatrice, Nebraska, without charge, provided, the defective part is returned to us transportation charges prepaid. **Return Authorization** is not required for cutter housings, electrical components, hydraulic components or belts. **Return Authorization** is required for all other components. The responsibility of Encore Mfg. Co., Inc. in respect to claim is limited to making the required repair or replacements, and no claim of breach of warranty shall be cause for cancellation or rescission of the contract of sale of any Encore mower. Proof of purchase will be required by the dealer to substantiate any warranty claim. All warranty work must be performed by an authorized Encore service dealer. This warranty is limited to two years from the date of original retail purchase for any Encore mower that is used for commercial purposes or 90 days rental. This warranty DOES NOT cover any Encore mower that has been subject to misuse, neglect, negligence, accident or that has been operated in any way contrary to the operating instructions as specified in the Operator's Manual. The warranty DOES NOT apply to any damage to the mower that is the result of improper maintenance, or to any mower parts that have not been assembled or installed as specified in the assembly instructions. The warranty DOES NOT cover any mower that has been altered or modified so as to adversely affect the intended use of the product, its operation, performance or durability. In addition, the warranty DOES NOT extend to repairs made necessary by normal wear or by the use of parts or accessories which, in the reasonable judgement of Encore Mfg. Co., Inc. are either incompatible with the mower or adversely affect its operation, performance or durability. This warranty DOES NOT cover the engine, which is warranted separately by the engine manufacturer and for different periods of time. This warranty DOES cover (if equipped) the battery for a period of 90 days. Encore Mfg. Co., Inc. reserves the right to change or improve the design of any mower without assuming any obligation to modify any mower previously manufactured. Encore Mfg. Co., Inc.'s obligation under warranty is strictly and excessively limited to repair or replacement of defective parts. Encore Mfg. Co., Inc. DOES NOT assume or authorize anyone to assume for them any other obligation. Some states do not allow limitations on how long an implied warranty lasts, so the above limitation may not apply to you. Encore Mfg. Co., Inc. assumes no responsibility for incidental, consequential or other damages including, but not limited to expense of delivering the mower to an authorized service dealer and expense of returning it back to the owner, mechanic's travel time, telephone or telegram charges, rental of a like product during the time warranty repairs are being performed, travel, loss of use of the mower, loss of time or inconvenience. Some states do not allow the exclusion or limitation of incidental or consequential damages so that above limitation or exclusion may not apply to you. This warranty gives you specific legal rights which vary from state to state.

ENCORE MFG. CO., INC. CANNOT BE RESPONSIBLE FOR THE WAY, OR CONDITIONS IN WHICH YOU OPERATE THE MOWER. USE COMMON SENSE AT ALL TIMES.

