

5001399 50" MULCH KIT

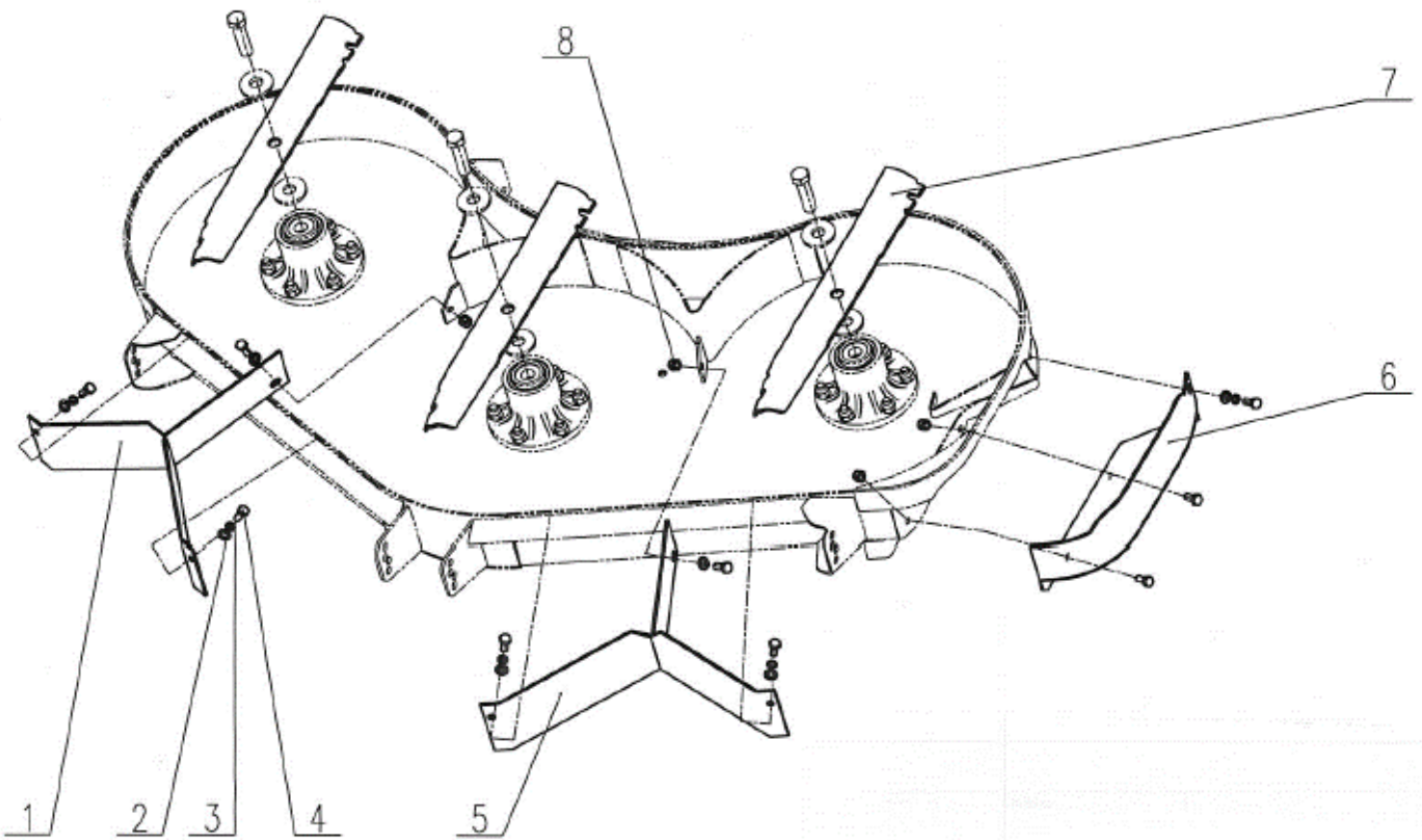

ITEM	PART NO.	DESCRIPTION	QTY
1	5001393	BAFFLE, LH MULCH	1
2	B97.1-8	WASHER 8	7
3	B93-8	LOCKWASHER 8	5
4	B5787-820	SCREW, HH FLANGE M8X20	9
5	5001396	BAFFLE, RH MULCH	1
6	5001390	COVER, MULCH	1
7	5001001A	MULCHING BLADE	3
8	B6182-8	NUT, NYLOC M8	4

INSTRUCTIONS:

1. Remove bird wing baffle from front left underside of the cutting deck and install the left and right mulch baffles provided in the kit. Attach with hardware provided 3 places for each baffle.
2. Remove standard blades from cutter spindles and install mulch blades. Torque the blade bolts to 50-60 ft-lb.
3. Remove discharge chute from deck and install block plate.